



RDF301, RDF600KN



RDF301.50



RDF301.50H



Semi-flush mount communicating room thermostats RDF301, RDF301.50..., RDF600KN

Basic documentation

Contents

1.	About this document	4
1.1	Revision history	4
1.2	New functions	4
1.3	Reference documents	5
1.4	Before you start	6
1.4.1	Copyright	6
1.4.2	Quality assurance	6
1.4.3	Document use / request to the reader	6
1.5	Target audience, prerequisites	7
1.6	Glossary	7
2.	Summary	8
2.1	Types	8
2.2	Ordering	8
2.3	Functions	8
2.4	Integration via KNX bus	10
2.5	Equipment combinations	12
2.6	Accessories	12
3.	Functions	13
3.1	Temperature control	13
3.2	Operating modes	14
3.2.1	Different ways to influence the operating mode	15
3.2.2	Communication examples	19
3.3	Room temperature setpoints	24
3.3.1	Description	24
3.3.2	Setting and adjusting setpoints	26
3.4	Applications overview	27
3.4.1	Applications for fan coil systems	28
3.4.2	Applications for Universal systems	29
3.4.3	Applications for heat pump systems	30
3.5	Additional functions	31
3.6	Control sequences	34
3.6.1	Sequences overview (setting via parameter P01)	34
3.6.2	Application mode	35
3.6.3	2-pipe fan coil unit	36
3.6.4	2-pipe fan coil unit with electric heater	38
3.6.5	4-pipe fan coil unit	40
3.6.6	Chilled / heated ceiling and radiator applications	41
3.6.7	Compressor applications	42
3.6.8	Setpoints and sequences	43
3.7	Control outputs	45
3.7.1	Overview	45
3.7.2	Control outputs configuration (setting via DIP switches or tool)	46
3.8	Fan control	47
3.9	Multifunctional input, digital input	50
3.10	Handling faults	52
3.11	KNX communications	53

3.11.1	S-Mode.....	53
3.11.2	LTE Mode.....	53
3.11.3	Zone addressing in LTE Mode (in conjunction with Synco).....	54
3.11.4	Example of heating and cooling demand zone.....	56
3.11.5	Send heartbeat and receive timeout.....	57
3.11.6	Startup.....	57
3.11.7	Heating and cooling demand.....	57
3.11.8	Fault function on KNX.....	58
3.11.9	KNX switching groups (RDF301.50, RDF301.50H only).....	59
3.12	Communication objects (S-Mode).....	61
3.12.1	Overview.....	61
3.12.2	Description of communication objects.....	62
3.13	Communication objects (LTE-Mode).....	65
3.14	Control parameters.....	66
3.14.1	Parameter setting via local HMI.....	66
3.14.2	Parameter setting / download via tool.....	67
3.14.3	Parameters of the "Service level".....	68
3.14.4	Parameters of the "Expert level with diagnostics and test".....	69
4.	Handling.....	72
4.1	Mounting and installation.....	72
4.2	Commissioning.....	73
4.3	Operation.....	75
4.4	Remote operation.....	76
4.5	Disposal.....	76
5.	Supported KNX tools.....	77
5.1	ETS.....	77
5.1.1	Parameter settings in ETS.....	77
5.2	ACS Service and Operating tool.....	78
5.2.1	Parameter settings in ACS.....	79
5.2.2	Operation and monitoring with ACS.....	80
5.2.3	Operation and monitoring with OZW772.....	83
5.2.4	Operation and monitoring with RMZ972.....	83
6.	Connection.....	84
6.1	Connection terminals.....	84
6.2	Connection diagrams.....	85
7.	Mechanical design.....	86
7.1	General.....	86
7.2	Dimensions.....	87
8.	Technical data.....	88
Index	90	

1. About this document

1.1 Revision history

Edition	Date	Changes	Section	Pages
2.4	2016-03-28	RDF600KN changes from SW V1.8 to V2.0 Presence detection function: - V1.8 with only standard presence - V2.0 with both standard presence (factory setting P77 = 1) and hotel presence (P77 = 2) Error handling and sensor errors - V2.0 with additional alarms Update Synco topology	All 3.10 2.4	All 54 11
2.3	2015-06-10	All Units: Update mounting notes and connection diagrams regarding overcurrent protection Replace directives with declaration document number	4.1 6.2 8	72 85 88
2.2	June 2014	Added RDF301.50H RDF600KN (SW V1.8) - Update window contact and presence detector function. For all models: Update with wiring and protection information New S-Mode objects for Economy setpoint	All	All
2.0	Oct 2012	Added RDF600...family	All	All
1.0	22 Jun 2010	First edition		

1.2 New functions

Availability of new functions depends on the software version used; see table below.

Firmware updates	RDF301 / RDF301.50 / RDF301.50H	RDF600KN		
	SW = V4.1	SW < V1.8	SW = V1.8	SW >= V2.0
Hotel presence				✓
Standard presence mode			✓	✓
External sensor error message Er3				✓
Window contact			✓	✓
Operating mode switchover contact	✓	✓		
Fan stage in dead zone (Comfort)			✓	✓
Fan start delay			✓	✓
Room temperature: S-Mode object Economy heating setpoint			✓	✓
Room temperature: S-Mode object Economy cooling setpoint			✓	✓

1.3 Reference documents

Subject	Ref	Doc No.	Description	
Semi-flush mount room thermostats with KNX communications, RDF301, RDF301.50, RDF600KN	[1]	CE1N3171	Data Sheet	
	[2]	CE1B3171	Operating Instructions	
	[3]	CE1M3171	Mounting Instructions RDF301...	
	[3a]	CE1M3076.1	Mounting Instructions RDF600KN	
KNX Manual	[4]		Handbook for Home and Building Control – Basic Principles (http://www.knx.org/knx-en/training/books-documentation/knx-association-books/index.php)	
Synco and KNX (see www.siemens.com/synco)	[5]	CE1N3127	KNX bus, Data Sheet	
	[6]	CE1P3127	Communication via the KNX bus for Synco 700, 900 and RXB/RXL, Basic Documentation	
	[7]	XLS template	Planning and commissioning protocol, in HIT communication Synco 700	
	[8]	CE1N3121	RMB795 central control unit, Data Sheet	
	[9]	CE1Y3110	KNX S-Mode data points	
	[10]	--	Product data for ETS	
	[11]	CE1J3110	ETS product data compatibility list	
	[12]	0-92168en	Synco Application Manual	
	Desigo engineering documents	[13]	CM1Y9775	Desigo RXB integration – S-Mode
		[14]	CM1Y9776	Desigo RXB / RXL integration – Individual Addressing
		[15]	CM1Y9777	Third-party integration
		[16]	CM1Y9778	Synco integration
[17]		CM1Y9779	Working with ETS	
Apogee engineering documents	[18]	565-132	Installation Instructions: KNX driver for PXC Modular	
	[19]	127-1676	Technical Spec Sheet: KNX driver for PXC Modular	
	[20]	140-0804	Technical reference for KNX driver	
	[21]	140-0804	Application 6205 point map for RDF	

1.4 Before you start

1.4.1 Copyright

This document may be duplicated and distributed only with the express permission of Siemens, and may be passed only to authorized persons or companies with the required technical knowledge.

1.4.2 Quality assurance

This document was prepared with great care.

- The contents of this document are checked at regular intervals
- Any corrections necessary are included in subsequent versions
- Documents are automatically amended as a consequence of modifications and corrections to the products described

Please make sure that you are aware of the latest document revision date.

If you find lack of clarity while using this document, or if you have any criticisms or suggestions, please contact the Product Manager in your nearest branch office.

The addresses of the Siemens Regional Companies are available at

www.buildingtechnologies.siemens.com.

1.4.3 Document use / request to the reader

Before using our products, it is important that you read the documents supplied with or ordered at the same time as the products (equipment, applications, tools, etc.) carefully and in full.

We assume that persons using our products and documents are authorized and trained appropriately and have the technical knowledge required to use our products as intended.

More information on the products and applications is available:

- On the intranet (Siemens employees only) at <https://workspace.sbt.siemens.com/content/00001123/default.aspx>
- From the Siemens branch office near you www.buildingtechnologies.siemens.com or from your system supplier
- From the support team at headquarters fieldsupport-zug.ch.sbt@siemens.com if there is no local point of contact.

Siemens assumes no liability to the extent allowed under the law for any losses resulting from a failure to comply with the aforementioned points or for the improper compliance of the same.

1.5 Target audience, prerequisites

This document assumes that users of the RDF KNX thermostats are familiar with the ETS and/or Synco ACS tools and able to use them.

It also presupposes that these users are aware of the specific conditions associated with KNX.

In most countries, specific KNX know-how is conveyed through training centers certified by the KNX Association (see www.knx.org/).

For reference documentation, see section 1.2.

1.6 Glossary

The inputs, outputs and parameters of an application can be influenced in various ways. These are identified by the following symbols in this document:



ETS

Parameters identified by this symbol are set using ETS.



ACS

Parameters identified by this symbol are set using the ACS tool.



Note!

Setting RDF KNX parameters is only supported by the following tool versions:

- ETS3 or higher
- ACS version 5.11 or higher



Inputs and outputs identified by this symbol communicate with other KNX devices. They are called communication objects (CO).

The communication objects of the RDF KNX thermostats work partly in S-Mode, partly in LTE Mode, and partly in both. These objects are described accordingly.

A list of the parameters is shown in section 3.13.

2. Summary

2.1 Types

Product no.	Stock no.	Operating voltage	Control outputs				Suitable conduit box ²⁾
			3-pos	ON/OFF	DC 0..10 V	KNX switching groups	
RDF301	S55770-T104	AC 230 V	1 ¹⁾	2 ¹⁾	--		square
RDF301.50	S55770-T105	AC 230 V	1 ¹⁾	2 ¹⁾	--	✓	square
RDF301.50H	S55770-T334	AC 230 V	1 ¹⁾	2 ¹⁾	--	Hotel: MUR, DND ³⁾	square
RDF600KN	S55770-T293	AC 230 V	1 ¹⁾	2 ¹⁾	--		Round or square

¹⁾ Selectable: ON/OFF or 3-position.

²⁾ Square conduit box e.g. ARG71.

Round CEE conduit box min 60 mm diameter and min 40 mm depth.

³⁾ MUR: Make Up Room, DND: Do Not Disturb.

2.2 Ordering

- When ordering, please indicate both product no. / stock no. and name:
E.g. RDF301 / S55770-T104 room thermostat.
- Order valve actuators separately.

2.3 Functions

Use

Fan coil units via ON/OFF or modulating control outputs:

- 2-pipe system
- 2-pipe system with electric heater
- 4-pipe system

Chilled / heated ceilings (or radiators) via ON/OFF or modulating control outputs:

- Chilled / heated ceiling
- Chilled / heated ceiling with electric heater
- Chilled / heated ceiling and radiator / floor heating

Compressors: Via ON/OFF control

- 1-stage compressors in DX type equipment
- 1-stage compressors in DX type equipment with electric heater

The room thermostats are delivered with a fixed set of applications.

The relevant application is selected and activated during commissioning using one of the following tools:

- Synco ACS
- ETS
- Local DIP switch and HMI

Features

- Operating modes: Comfort, Economy (Energy Saving) and Protection
- ON/OFF or 3-position control outputs (relay)
- Output for 3-speed or 1-speed fan
- Automatic or manual heating / cooling changeover
- Backlit display
- AC 230 V operating voltage

Type of mounting / suitable conduit boxes

- RDF600KN for round CEE conduit box, with min 60 mm diameter, min 40 mm depth or recessed square CEE conduit box with 60.3 mm fixed centers
- RDF301... for recessed square CEE conduit box with 60.3 mm fixed centers

Functions

- Room temperature control via built-in temperature sensor or external room temperature / return air temperature sensor.
- Changeover between heating and cooling mode (automatic via local sensor or bus, or manually).
- Selection of applications via DIP switches or commissioning tool.
- Select operating mode via operating mode button on the thermostat.
- Temporary Comfort mode extension.
- 1- or 3-speed fan control (automatically or manually).
- Display of current room temperature or setpoint in °C and/or °F.
- Minimum and maximum limitation of room temperature setpoint.
- Button lock (automatically or manually).
- 2 multifunctional inputs, freely selectable for:
 - Sensor for automatic heating / cooling changeover
 - External room temperature or return air temperature sensor
 - Dew point sensor
 - Electric heater enable
 - Fault input
 - Monitor input for temperature sensor or switch state
- RDF301...
 - Operating mode switchover contact ... (keycard, window contact, etc.)
- RDF600KN:
 - Window contact
 - Presence detector (Standard presence mode and Hotel presence)
See pages 15 & 18.
- Advanced fan control function, e.g. fan kick, fan start, selectable fan operation (enable, disable or depending on heating or cooling mode).
- "Purge" function together with 2-port valve in a 2-pipe changeover system.
- Reminder to clean fan filters (adjust with P62).
- Floor heating temperature limitation.
- Reload factory settings for commissioning and control parameters.

2.4 Integration via KNX bus

The RDF room thermostats can be integrated as follows:

- Integration into Synco 700 system via LTE Mode (easy engineering).
- Integration into Synco living via group addressing (ETS).
- Integration into Desigo and Apogee via group addressing (ETS) or individual addressing.
- Integration into third-party systems via group addressing (ETS).

The following KNX functions are available:

- Central time program and setpoints, e.g. when using the RMB795 central control unit.
- Outside temperature or time of day via bus displayed on thermostat.
- Remote operation and monitoring, e.g. using the RMZ792 bus operator unit.
- Remote operation and monitoring with web browser using the OZW772 web server.
- Maximum energy efficiency due to exchange of relevant energy information, e.g. with Synco 700 controllers (e.g. heating demand, cooling demand).
- RDF301.50 only: 4 buttons to control KNX actuators via KNX S-Mode ("switching groups" with functions such as switching, dimming, blinds control, 8-bit scene).
- RDF301.50H only: 4 buttons for Hotel applications to control via KNX S-Mode. Same functions as RDF301.50, but with dedicated button labels for hotel applications: Make Up Room, Do Not Disturb.
- Alarming, e.g. external fault contact, condensation, clean filter, etc.
- Monitoring input for temperature sensor or switch.

Engineering and commissioning can be done using...

- local DIP switches / HMI
- Synco ACS service tool
- ETS

Synco 700

The RDF room thermostats are especially tailored for integration into the Synco 700 system and operate together in LTE Mode. This extends the field of use of Synco for individual room control in conjunction with fan coil units, VAV, chilled ceilings and radiators.

Synco living

Thanks to S-Mode extension to the QAX9x3 central apartment unit, communicating room thermostats can be easily integrated into Synco living systems. Using the S-Mode data points of the central apartment unit, additional room information can be exchanged with the room thermostat via KNX TP1 (RF function is not available on the room thermostats). To make the integration, the ETS engineering tool is required.

Synco topology

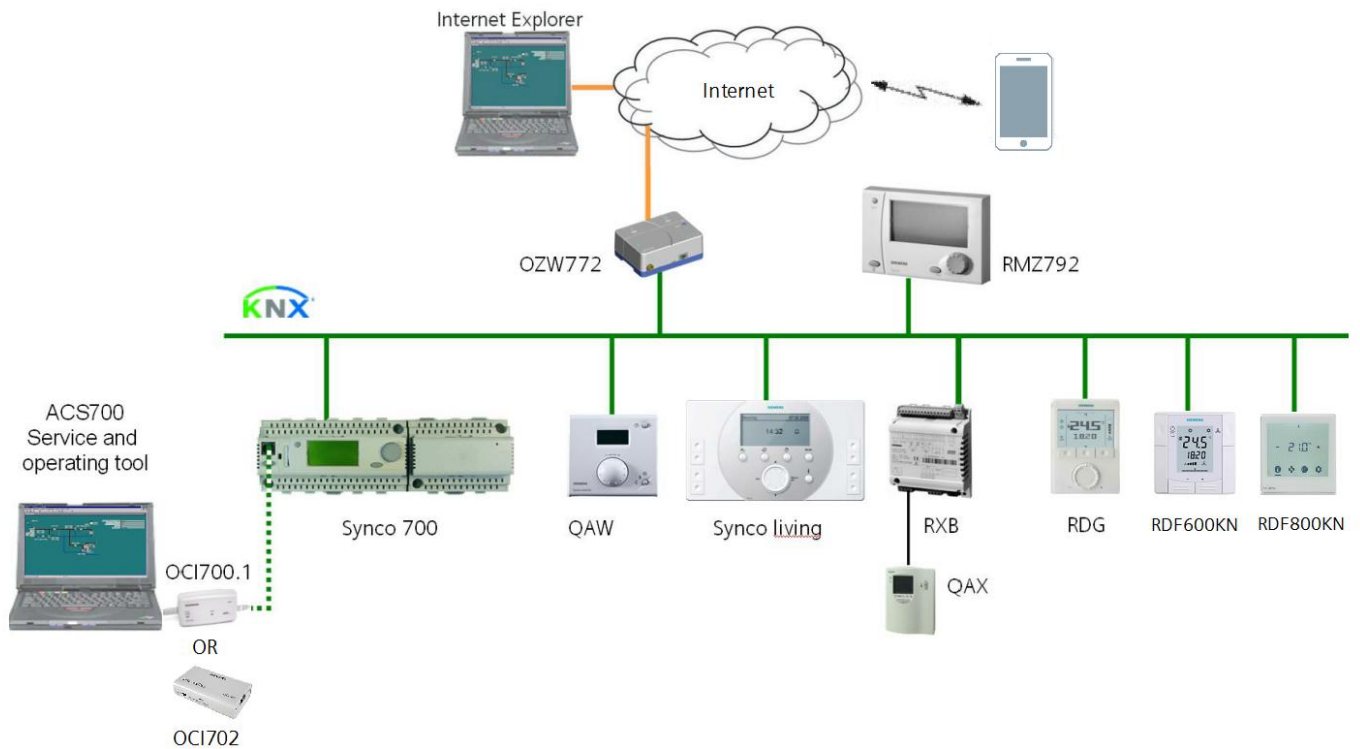













Legend:

Synco 700	Building automation and control system (BACS)
Synco living	Room automation and control system
RDG..., RDF...	Room thermostats
OZW772	Web server
RMZ792	Bus operator unit
QAW...	Room unit
ACS	Service tool using OCI700.1 and OCI702 (OCI700.1 and OCI702 are delivered with a service cable which can be plugged into the service connector on a Synco controller)
RXB	Room controllers
QAX	Room unit for RXB room controllers

Desigo, Apogee and third-party systems

The RDF KNX devices can be integrated into the Siemens building automation and control systems (BACS) Desigo / Apogee or into 3rd-party systems. For integration, either S-Mode (group addressing) or individual addressing can be used.



2.5 Equipment combinations

	Description	Product no.	Data sheet ^{*)}
	Cable temperature sensor or changeover sensor	 QAH11.1	1840
	Room temperature sensor	 QAA32	1747
	Condensation monitor	 QXA21..	A6V10741072
ON/OFF actuators	Electromotoric ON/OFF actuator	 SFA21...	4863
	Electromotoric ON/OFF valve and actuator (only available in AP, UAE, SA and IN)	 MVI... / MXI...	4867
	Zone valve actuator (only available in AP, UAE, SA and IN)	 SUA...	4832
	Thermal actuator (for radiator valves) NO	 STA23...	4884
	Thermal actuator (for small valves 2.5 mm), NC	 STP23...	4884
3-position actuators	Electrical actuator, 3-position (for radiator valves)	 SSA31...	4893
	Electrical actuator, 3-position (for 2- and 3-port valves / V...P45)	 SSC31	4895
	Electrical actuator, 3-position (for small valves 2.5 mm)	 SSP31...	4864
	Electrical actuator, 3-position (for small valves 5.5 mm)	 SSB31...	4891
	Electrical actuator, 3-position	 SAS31...	4581

*) The documents can be downloaded from <http://siemens.com/bt/download>.

- Note: For the maximal number of actuators in parallel, refer to information in the data sheets of the selected actuators and to this list, depending on which value is lower:
- Parallel operation of max 6 SS... actuators (3-pos) is possible.
 - Parallel operation of max 10 ON/OFF actuators is possible.

2.6 Accessories

Description	Product no. / SSN	Data sheet
Changeover mounting kit (50 pcs/package)	 ARG86.3	N3009
Plastic mounting bracket for semi-flush-mount thermostats RDF301... for increasing the headroom in the conduit box by 10mm	 ARG70.3	N3009
Conduit box for semi-flush mounted thermostat RDF301...	 ARG71 / S55770-T137	N3009
KNX Power supply 160 mA (Siemens BT LV)	5WG1 125-1AB02	--
KNX Power supply 320 mA (Siemens BT LV)	5WG1 125-1AB12	--
KNX Power supply 640 mA (Siemens BT LV)	5WG1 125-1AB22	--

3. Functions

3.1 Temperature control

General note: Parameters

Setting of the control parameters (P01, etc., mentioned throughout the document) is described in section 3.13.

Temperature control

The thermostat acquires the room temperature via built-in sensor, external room temperature sensor (QAA32), or external return air temperature sensor (QAH11.1), and maintains the setpoint by delivering actuator control commands to heating and/or cooling equipment. The following control outputs are available:

- ON/OFF control (2-position)
- Modulating PI/P control with 3-position control output (only for 2-pipe applications)

The switching differential or proportional band is 2 K for heating mode and 1 K for cooling mode (adjustable via parameters P30 and P31).

The integral action time for modulating PI control is 5 minutes (RDF301...) and 45 minutes (RDF600KN), adjustable via parameter P35.

Display





The display shows the acquired room temperature or the Comfort setpoint, selectable via parameter P06. The factory setting displays the current room temperature. Use parameter P04 to change the room temperature display from °C to °F as needed.

The acquired room temperature (internal or external sensor) is also available as information on the bus.



Room temperature



- With **automatic** changeover or continuous heating / cooling, symbols  /  indicate that the system currently heats or cools (heating or cooling output is activated).
- With **manual** changeover (P01 = 2), symbols  /  indicate that the system currently operates in heating or cooling mode. Thus, the symbols are displayed even when the thermostat operates in the neutral zone.

Concurrent display of
°C and °F

Concurrent display of the current temperature or setpoint in °C and °F (parameter P07 = 1) is possible on the thermostats.



Outside temperature via
bus

The outside temperature can be displayed on the room thermostat by setting parameter P07 = 2. This temperature value has only information character. In LTE Mode, the outside temperature can only be received on outside temperature zone 31.

In S-Mode, the corresponding communication object needs to be bound with a KNX sensor device.



Time of day via bus

Time of day via bus can be displayed on the room thermostat by setting parameter P07 = 3 or 4. The display format is either in 12- or in 24-hour format.

The information can be received from a Synco controller with time master functionality or any other KNX device if the corresponding communication object is bound.

- Note:
- When an application program is downloaded to the Synco devices via ETS, the correct group addresses need to be downloaded as well to display the time of day on the room thermostat (see Synco Knowledge Base - KB771).

3.2 Operating modes

The thermostat's operating mode can be influenced in different ways (see below). Specific heating and cooling setpoints are assigned to each operating mode.

The thermostat sends the effective room operating mode on the bus.

The following operating modes are available:



Room operating mode:
State

Auto Timer

In Auto Timer mode the room operating mode is commanded via bus. Auto Timer is replaced by Comfort when no time schedule via bus is present

Comfort

In Comfort mode, the thermostat maintains the Comfort setpoint. This setpoint can be defined via parameters P8, P9 and P10.

It can be locally adjusted via the +/- buttons or via bus.

In Comfort mode, the fan can be set to automatic or manual fan speed: Low, medium or high.



Presence detector
(RDF600KN)

Standard presence mode:

The thermostat switches to Comfort mode when the presence detector (local or on KNX) is active (room is occupied). *)

Hotel presence mode:

When hotel guests leave their rooms, the thermostat switches to Economy mode and the local HMI (keys) is locked. Upon occupancy, the thermostat returns to the previous operating mode set by the hotel guests.

Economy

The setpoints (less heating and cooling than in Comfort mode) can be defined via parameters P11 and P12.

The thermostat switches to Economy mode when...

- the operating mode button is pressed (only possible if parameter P02 is set to 2)
- Economy is sent via bus
- an operating mode switchover contact on RDF301... (e.g. keycard contact presence detector, window contact) is active. *)
- "Window state" is sent to the RDF301 via bus, e.g. from a KNX switch or a KNX presence detector (P02 is irrelevant) *)



Room operating mode:
Window state
(RDF301...)

Protection

In Protection mode, the system is...

- protected against frost (factory setting 8 °C, can be disabled or changed via P65)
- protected against overheating (factory setting OFF, can be enabled or changed via P66)

No other operating mode can be selected locally if Protection mode is commanded via bus. and are displayed.



Room operating mode:
Window state
(RDF600KN)

The thermostat switches to Protection mode when...

- the operating mode button is pressed
- Protection is sent via bus
- the window contact on RDF600KN is active (open window).
- "Window state" is sent to the RDF600KN via bus, e.g. from a KNX switch *)

Note: *) Refer to chapter 3.2.1 for detail regarding the operating mode switchover contact (RDF301...), window contact (RDF600KN) and presence detector (RDF600KN).

3.2.1 Different ways to influence the operating mode

Source for change of operating mode



ACS

The operating mode can be influenced by different interventions.
The source of the effective room operating mode state can be monitored using the "Cause" diagnostic data point in the ACS tool, operator unit RMZ792 or web server OZW772.

Source	Description	Value of DP "Cause"
Local operation via operating mode button	<ul style="list-style-type: none"> Operating mode is not Auto Timer No time schedule via bus 	Room operating mode selector (pre-selection)
	<ul style="list-style-type: none"> Temporary Comfort extension is active 	Timer function
	<ul style="list-style-type: none"> Operating mode switchover contact (RDF301..) 	Room operating mode contact
	<ul style="list-style-type: none"> Window contact (RDF600KN)¹⁾ 	Window switch
	<ul style="list-style-type: none"> Presence detector (RDF600KN)¹⁾ 	Presence detector
Bus command  Room op. mode	<ul style="list-style-type: none"> "Window state" sent via bus (RDF301....) 	Room operating mode contact
	<ul style="list-style-type: none"> "Window state" sent via bus (RDF600KN)¹⁾ 	Window switch
	<ul style="list-style-type: none"> "Presence detector" sent via bus (RDF600KN)¹⁾ 	Presence detector
	<ul style="list-style-type: none"> Time schedule available via bus → local operating mode is set to Auto Timer Time schedule sends Protection mode via bus → operating mode cannot be changed locally 	Time switch

1) RDF600KN SW version < V1.8 works like RDF301... with the operating mode switchover contact.

Priority of operating mode interventions





The following table shows the priorities of different interventions.
A lower number means a higher priority.

Priority	Description	Remark
①	Commissioning	In parameter setting mode (highest priority), you can always command an operating mode independent of all other settings or intervention via bus and local input.
②	Protection mode via bus from time schedule	Protection mode, sent by a time schedule, has priority 2. It cannot be overridden by the user nor by an operating mode switchover contact.
③	Operating mode switchover contact (RDF301...)	If the contact is closed, the operating mode changes to Economy. This overrides the operating mode on the thermostat.
③	Window contact (RDF600KN) ¹⁾	If the contact is closed, the operating mode changes to Protection. This overrides the operating mode on the thermostat.
③	"Window state" via bus	"Window state" sent via bus has the same effect as the local operating mode switchover contact (on RDF301...) or local window contact (on RDF600KN).
		<i>Note: Only one input source must be used, either local input X1/X2 or KNX bus.</i>
④	Presence detector (RDF600KN) ¹⁾	Standard presence mode: The thermostat switches to Comfort mode when the presence detector (local or on KNX) is active (room is occupied). ^{*)} Hotel presence mode: When hotel guests leave their rooms, the thermostat switches to Economy mode and the local HMI (keys) is locked. Upon occupancy, the thermostat returns to the previous operating mode set by the hotel guests.
④	Presence detector via	"Presence detector" sent via bus has the same effect as the

	bus (on RDF600KN) ¹⁾	local presence detector.
④	Operating mode button	The user can switch the operating mode using the operating mode button.
④	Operating mode via bus	The operating mode can be changed via bus.
④	Temporary extended Comfort mode via operating mode button	The operating mode can be temporarily set from Economy to Comfort by pressing the operating mode button, if... – Economy was sent via bus – extended Comfort period >0 (parameter P68) <i>The last intervention wins, either locally or via bus.</i>
④	Time schedule via bus	The operating mode sent via bus can be overridden by all other interventions. <i>Exception: Protection mode has priority 2.</i> Note: If the time schedule switches from Comfort to Economy, but the presence detector is still active (room occupied), the thermostat continues to work in Comfort mode for the period of occupancy.

1) RDF600KN SW version < V1.8 works like RDF301... with the operating mode switchover contact as window contact or presence detector.

Auto Timer mode with time schedule via bus

If a time schedule via bus is present, e.g. from central control unit, then the Auto Timer mode  is active. The thermostat automatically changes between Auto Comfort and Auto Economy according to the time schedule via bus. The display shows the Auto Timer mode symbol  along with the symbol for the effective room operating mode (Auto Comfort  or Auto Economy ). By pressing the operating mode button, you can change to another operating mode. Automatic fan is the default fan speed in Auto Timer mode.

Behavior when bus sends new operating mode

Each time the time schedule sends a new operating mode (switching event), the operating mode of the thermostat is set back to Auto Timer mode. This is to assure that the room temperature is maintained according to the time schedule.

Pre-Comfort via bus











If the time schedule sends Pre-Comfort mode, then this mode will be transformed either into Economy (factory setting) or Comfort (selectable via parameter P88).

Behavior when bus sends Protection

No intervention is possible neither by the user nor by an operating mode switchover contact, if Protection mode is set by the time schedule. OFF flashes on the display when the user presses a button.

Availability of Economy mode

The operating mode can be selected locally via the operating mode button. The behavior of the operating mode button (user profile) can be defined via parameter P02, factory setting is P02 = 1.

P02	Without time schedule	With time schedule via bus	Description
1	 → 	 → 	<ul style="list-style-type: none"> Switching manually between 2 modes, Economy is not available (factory setting). Suited for hotel guest rooms or commercial buildings. If a time schedule via bus is available, then the Comfort mode can be temporarily extended (see below).
2	 →  → 	 →  →  → 	<ul style="list-style-type: none"> Switching manually between 3 modes. Suited for homes and rooms where manual switching to Economy mode is desired.

**Operating mode
switchover contact
(window contact)
(RDF301...)**

The thermostat can be forced into Economy mode (e.g. when a window is opened, when a presence detector signals "no one present", when the keycard of a hotel room is withdrawn, etc). The contact can be connected to multifunctional input X1, X2. Set parameter P38, P40 to 3. P02 is not relevant. User operations are ineffective and "OFF" is displayed if the operating mode switch over contact is active.

**Window contact
(RDF600KN)**

The thermostat can be forced into Protection mode when the window is opened. The contact can be connected to multifunctional input X1, X2. Set parameter P38, P40 to 3. User operations are ineffective and "OFF" is displayed if the window contact is active.

Note: RDF600KN SW version < V1.8 works like RDF301... with the operating mode switchover function.



Room operating mode:
Window state

The function (operating mode switchover or window contact) is also available via the KNX signal "Window state", e.g. from a KNX switch or a KNX presence detector.

Note: Only one input source must be used, either local input X1/X2 or KNX bus. User operations are ineffective and "OFF" is displayed if the operating mode switchover/ window contact is active, or if "Window state" is sent via bus.



Room operating mode:
Presence detector
(RDF600KN)

The operating mode can be changed to Comfort and back to Economy mode depending of the room occupancy (room occupied or not occupied, via presence detector or keycard).

**Standard presence mode:
(factory setting P77=1)**

Behavior without time schedule:

- Whenever the presence detector is activated then the operating mode of the thermostat goes to Comfort.
- Whenever the presence detector is deactivated then the operating mode goes to Economy.

Behavior with time schedule via bus:

- When Time-switch is on Protection
 - Presence detector has not influence on operating mode.
- When Time-switch is on Economy
 - Whenever the presence detector is activated then the operating mode goes to Comfort.
 - Whenever the presence detector is deactivated then the operating mode goes to (Auto) Economy.
- When Time-switch is on Comfort
 - Whenever the presence detector is activated then the operating mode keeps in Comfort.
 - Whenever the presence detector is deactivated then the operating mode keeps in Comfort.

Important: When Time-switch goes to Eco but Presence detector is still active, the operating mode keeps in Comfort mode until the Presence detector is inactive.

Note: The contact (e.g. a card reader) can be connected to multifunctional input X1, X2 (set parameter P38 or P40 to 10) or the occupancy is sent via bus from a KNX presence detector sensor: *Only one input source must be used, either local input X1/X2 or KNX bus.*

Hotel presence mode:
(P77=2)

This function can be selected via parameter P77=2.

The presence detector status can be set via card reader or presence detector connected to the local multifunctional input (set P38 or P40 to 10) or via KNX (S-Mode).

Response when the room is unoccupied, i.e. when the key card is removed from the card reader or when the presence detector no longer detects movement.

- The operating mode of the thermostat switches to Economy.
- Changing the operating mode via local HMI is not possible (locked HMI) to ensure Economy is active when rooms are unoccupied.

Note: The operating mode can still be changed via bus, e.g. the hotel front desk switches the operating mode to Protection upon check-out or extended vacancy.

Response when the room is occupied, i.e. when the key card is inserted or when the presence detector detects movement.

- The thermostat returns to the last operating mode set for occupancy (either Protection or Comfort)

Note: If the operating mode is changed via bus during vacancy, the change is not based on detection, e.g. front desk can set the operating mode to Comfort after guests check in.

Temporary timer to extend the Comfort mode

Comfort mode can be temporarily extended (e.g. working after business hour or on weekends) when the thermostat is in Economy mode. The operating mode button switches the operating mode back to Comfort for the period preset in P68. Press the operating mode button again to stop the timer.

The following conditions must be fulfilled:

- mode selection via operating mode button is set to "Protection-Auto" (P02 = 1) and the time schedule via bus is Economy.
- Parameter P68 (extend Comfort period) is greater than 0.

During the temporary Comfort mode extension, symbol  appears.

If parameter P68 (extend Comfort period) = 0, extended Comfort cannot be activated; pressing the operating mode button will switch the thermostat to Protection.

If the operating mode switchover contact is active, pressing the operating mode button will show "OFF" (blinking).

3.2.2 Communication examples

The following examples show two typical applications of a central time schedule in conjunction with local control of the room operating mode.

The room operating mode in rooms 1...2 of a building is determined by the time schedule. Window contacts are fitted in all rooms.

The following conditions are specified:

The rooms are used and controlled by the time schedule as follows:

- Night setback from 17:00 to 08:00 (Economy)
- Protection from 20:00 to 06:00
- Lunch break from 12:00 to 13:00 (Pre-Comfort).

The substitution (parameter P88) for Pre-Comfort via bus is set on the thermostats as follows:

- Room 1: Comfort (1)
- Room 2: Economy (0).

Example 1 (RDF301...)

Operating mode switchover

In **room 1**, the window is opened briefly, once in the morning, once in late afternoon and once at night (1). Only the opening in the morning has a direct impact on the effective room operating mode.

During lunch break, the time schedule changes to Pre-Comfort. The mode remains in Comfort as set by parameter "Transformation Pre-Comfort" (P88 = 1).

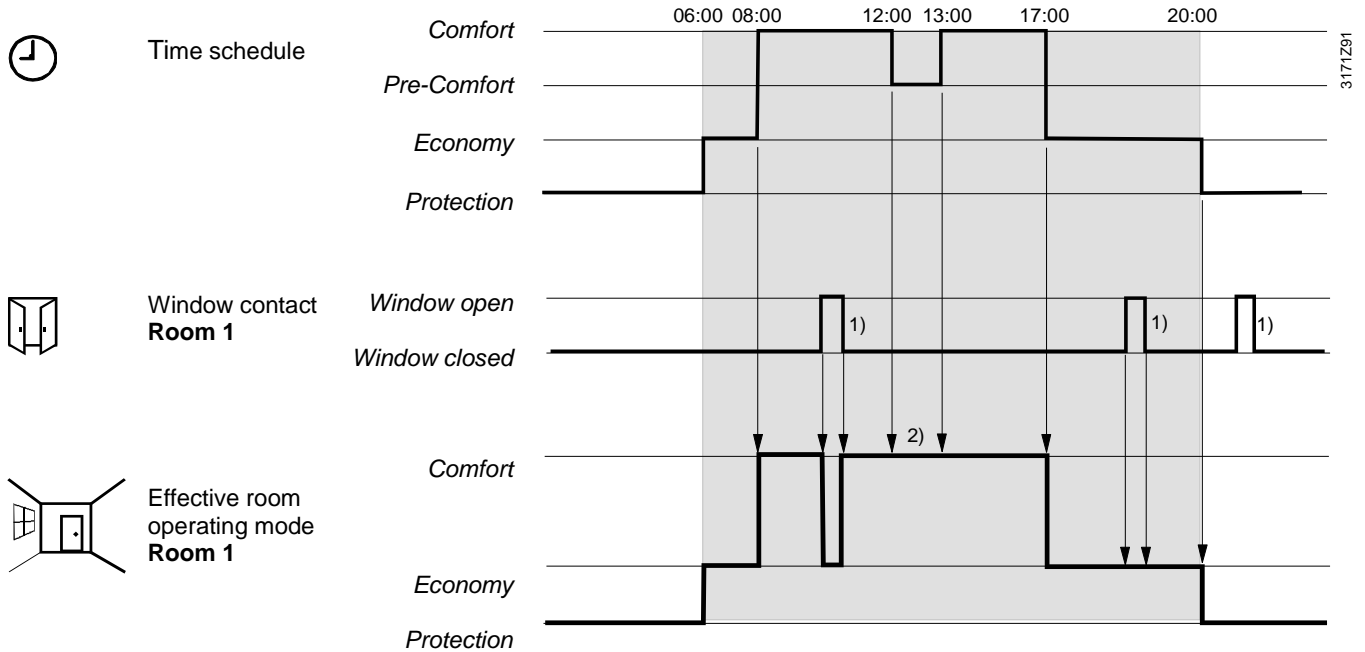

Example 2 (RDF301...)

Interaction of user operation (operating mode button) and central time schedule

In **room 2**, the window is opened briefly, once in the morning and once at night (1). Only the opening in the morning has a direct impact on the effective room operating mode.

With the operating mode button, the operating mode can be changed between OFF and Auto or temporary Comfort extension respectively.

- During lunch break, the time schedule changes to Pre-Comfort. The mode of the thermostat changes to Economy as set by parameter "Transformation Pre-Comfort". (P88 = 0) (6)
- During lunch break, the user changes the operating mode to Comfort (temporary Comfort extension) by pressing the operating mode button. (2)
At 13:00, the timer is reset due to mode change of the central time schedule
- In the afternoon, the user switches the thermostat off by pressing the operating mode button. (3) At 17:00 the user setting is reset to Economy by the time schedule.
- At 19:30, the user again extends the Comfort mode (4). At 20:00, the timer is reset by the time schedule.
- After 20:00, pressing the operating mode button has no effect, as the central time switch sets the thermostat to Protection. (5)

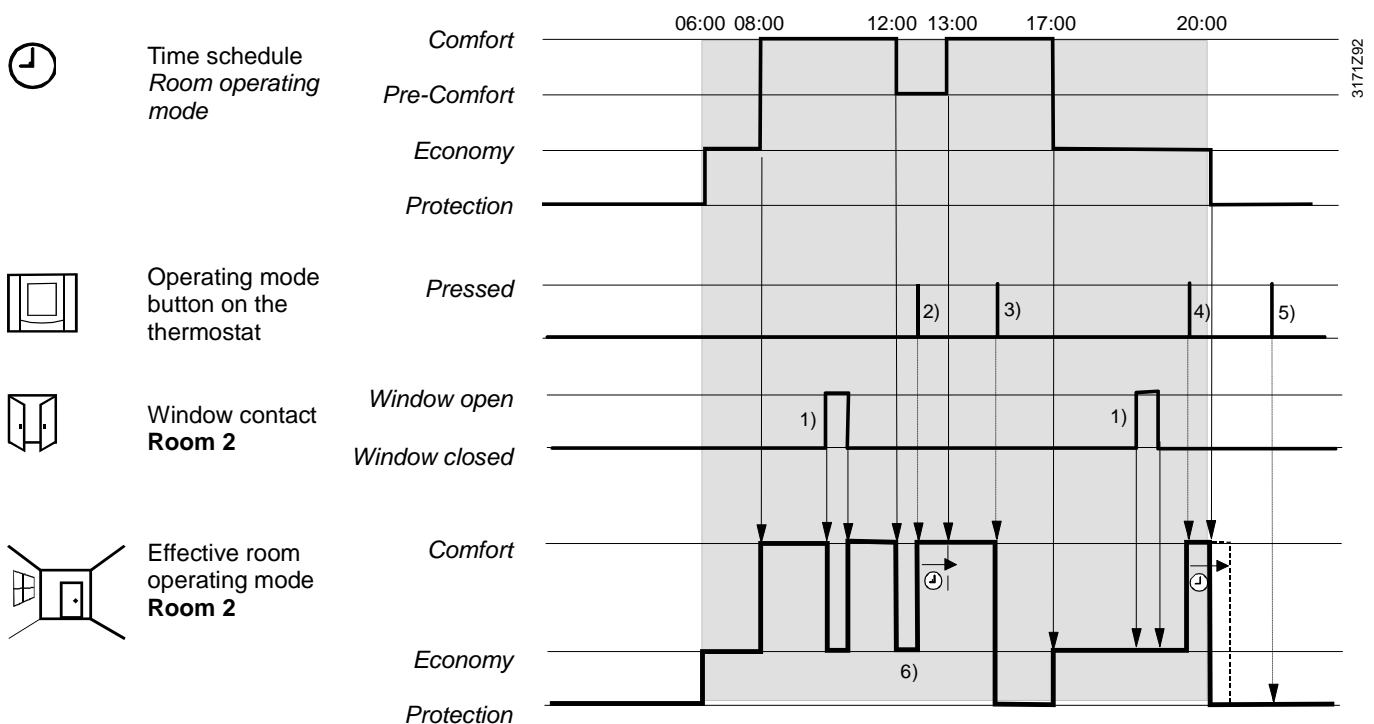

Example 3 (RDF600...)

Application with "Window Contact", "Standard Presence Detector" and central time schedule

In **room 3** operating mode Comfort is possible between 6:00 and 20:00, based on time schedule or occupancy period. Outside this time the operating mode remains in Protection.

- At 6:00 the central set the operating mode to Economy. (1)
- In the morning, as soon as the presence is detected (8:00 – 12:00), the operating mode will be switched to Comfort. (2)
- The user will briefly open the window and the operating mode switches to Protection. (3)
- In the afternoon the time schedule set the Comfort mode from 13:00 to 17:00. (4)
- After 17:00 the room is still occupied and the operating mode remains in Comfort (occupancy via presence detector). (5)
- Later people open the window and left the room for a short time. Operating mode switches to Protection as long as the window is open. (6)
- As soon as the room is unoccupied the thermostat switches to Economy. (7)
- At 20:00 the room is set to protection according to time schedule. (8)
- After this time, the occupancy detected via presence detection has not effect, as the central time switch sets the thermostat to Protection. (9)

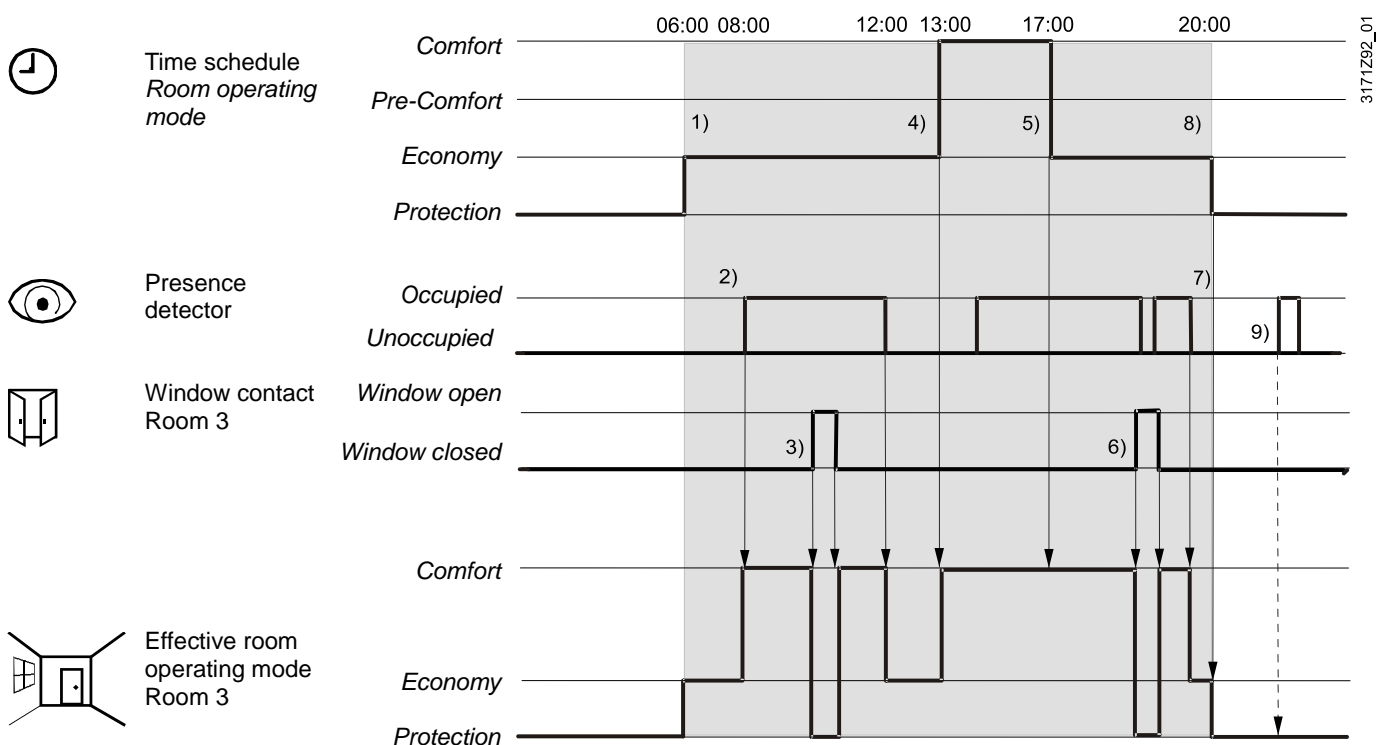

Note: RDF600KN SW version < V1.8 works like RDF301... with the operating mode switchover function.

**Example 4
(RDF600KN)**

Application with hotel presence detection function via key card reader

In **room 4**, hotel presence detection is selected via parameter P77, and the multifunctional input X1/X2 (set parameter P38 or P40 to 10) is connected to a card reader in a hotel application.

- At 6:00 when the room is vacant, i.e. no key card inserted in the card reader, the thermostat's operating mode is set to Economy. (1)
- At 8:00 when the room is occupied, i.e. a key card inserted in the card reader, the operating mode returns from Economy to the previous mode¹⁾ (2)
- A guest changes the operating mode to Comfort by pressing the operating mode button. (3)
- The guest then opens a window and the operating mode immediately switches to Protection. As soon as the window is closed, the operating mode is returns to Comfort. (4)
- If the guest leaves the hotel room or removes the key card, the operating mode returns to Economy, and the thermostat remains on Economy as the local HMI²⁾ is locked, i.e. the operating mode cannot be changed if no key card is inserted. (5)
- When the guest returns to the hotel (room occupied), the operating mode returns to the mode (Comfort) set previously by the guest. (6)
- When the guest turns off the room thermostat before going to sleep, the room operating mode switches to Protection. (7)
- As the guest wakes up, he/she turns on the thermostat and the operating mode switches to Comfort. (8)
- As soon as the room is unoccupied (guest leaves the room), the thermostat returns to Economy to save energy. (9)
- When the guest checks out of the hotel, the operating mode can be set to Protection via bus. (10)

Note:

1) The previous mode is the operating mode selected by either hotel guests via local HMI, or the operating mode sent via bus.

2) Local HMI means operation by means of buttons, including setpoint adjustments, fan speed, operating mode, etc.

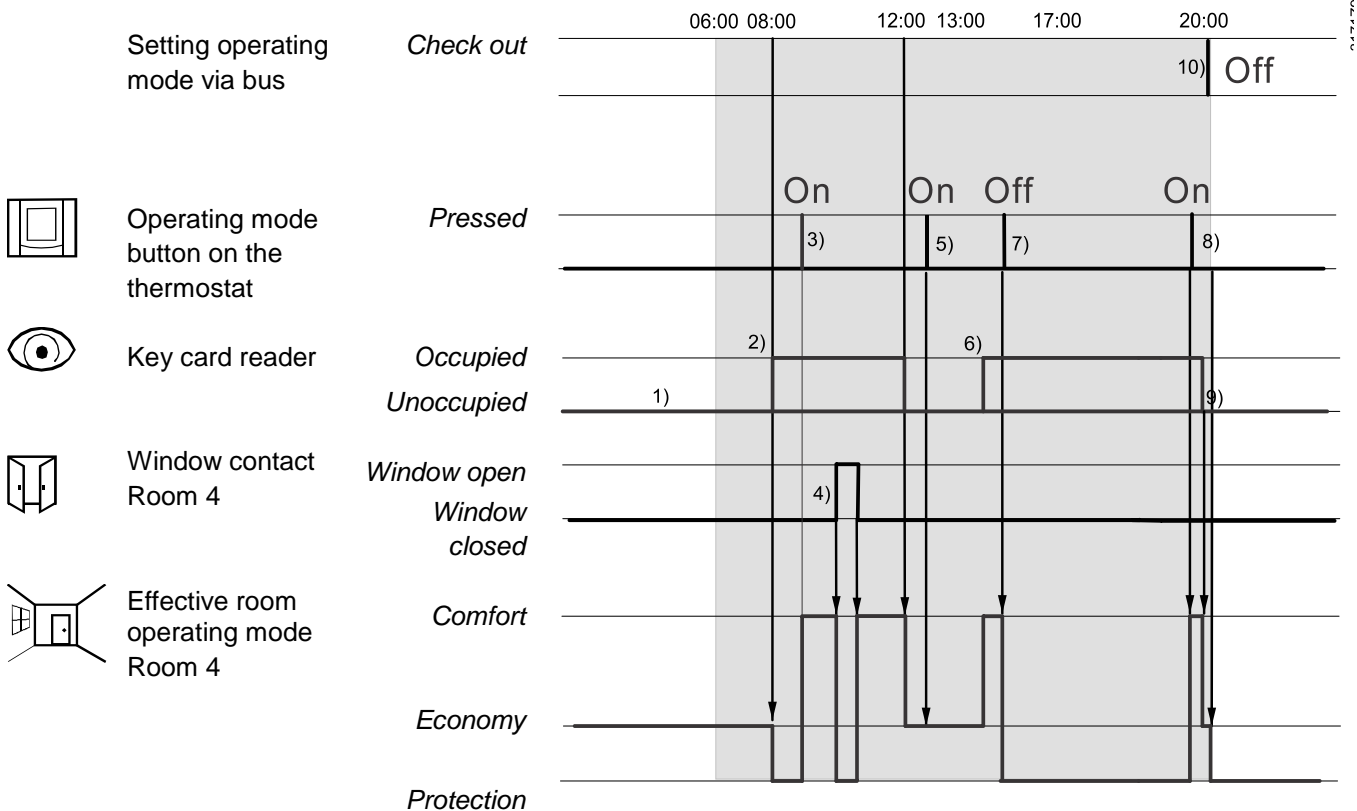

Note:

RDF600KN SW version < V1.8 works like RDF301... with the operating mode switchover function.

3.3 Room temperature setpoints

3.3.1 Description

Comfort mode ☀ The factory setting for the Comfort basic setpoint is **21 °C** and can be changed in the thermostat's EEPROM via parameter P08 or via bus with communication object "Comfort basic setpoint". The last intervention always wins.

The Comfort setpoint can be adjusted via the **+/-** buttons, or via bus from a remote device like a touchpanel, operating unit, etc. The last intervention always wins.

Temporary setpoint If the "Temporary setpoint" function is enabled via parameter P69, the Comfort setpoint adjusted via the **+/-** buttons or via bus is set back to the Comfort basic setpoint stored in P08 when the operating mode changes.

Setpoint limitation For comfort or energy saving purposes, the setpoint setting range can be limited to minimum (P09) and maximum (P10).

- P09 < P10
(comfort concept)
- If the minimum limit P09 is set lower than the maximum limit P10, both heating and cooling are adjustable between these 2 limits.
 - The customer adjusts the desired setpoint and the thermostat controls the room temperature accordingly.
 - For 4-pipe applications *), the selected comfort setpoint is in the middle of the dead zone (P33). The unit stops to energize the heating / cooling outputs as soon as the room temperature reaches the dead zone.

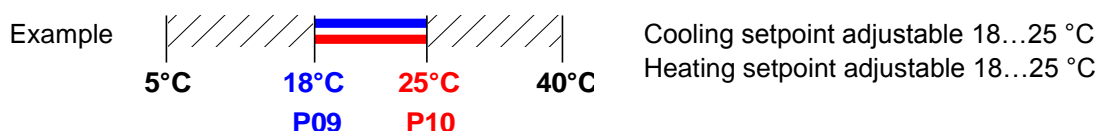

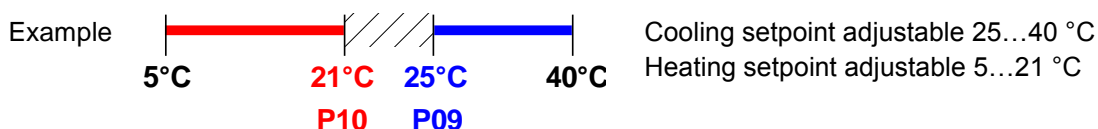

- P09 ≥ P10
(energy saving concept)
- If the minimum limit **P09 is set higher** than the limit P10, then
 - The setting range of cooling setpoint is from **P09...40 °C** in place of 5...40 °C
 - The setting range of heating setpoint is from **5...P10 °C** in place of 5...40 °C. This allows the user to limit the maximum heating setpoint and the minimum cooling setpoint. This concept helps to save energy costs.
 - For 4-pipe applications *):
 - The thermostat runs with the setpoint of the active sequence:
 - In heating mode, the heating setpoint is active and adjustable via rotary knob.
 - In cooling mode, the cooling setpoint is active and adjustable via rotary knob.
 - Switching from the heating setpoint to the cooling setpoint and vice-versa occurs when the room temperature reaches the adjusted limitation (P09 or P10) of the **inactive** sequence. E.g. the thermostat is in heating sequence and runs with the heating setpoint. When the room temperature reaches P09, the thermostat switches to cooling mode and runs with the cooling setpoint, as long as the room temperature does not drop below P10.



- *) Note: RDF301...
for 4-pipe with P09 ≥ P10
- For heating **and** cooling applications (e.g. 4-pipe):
 - **P09** is the setpoint for cooling and **P10** the setpoint for heating.
 - The setpoint cannot be adjusted via the rotary knob.

Economy mode ☾ Use control parameters P11 and P12 to adjust the Economy mode setpoints. The heating setpoint is factory-set to **15 °C**, and the cooling setpoint to **30 °C**.

Protection mode  Use control parameters P65 and P66 to adjust the Protection mode setpoints. The heating setpoint is factory-set to **8 °C** (frost protection) and to **OFF** for cooling.

Caution  If a setpoint (Economy or Protection) is set to OFF, the thermostat does not control the room temperature in the corresponding mode (heating or cooling). This means no protective heating or cooling function and thus risk of frost in heating mode or risk of overtemperature in cooling mode!

The Economy setpoints are accessible at the service level (P11, P12); the Protection setpoints at the expert level (P65, P66).

3.3.2 Setting and adjusting setpoints

Room temperature setpoints can be

- set during commissioning
- adjusted during runtime



Comfort basic setpoint
Comfort setpoint
Economy heating setpoint
Economy cooling setpoint

The source can be

- the local HMI
- a tool
- a central control unit

The thermostat stores the setpoints

- in EEPROM in the form of parameters
- in the runtime memory

The table below shows the interrelations:

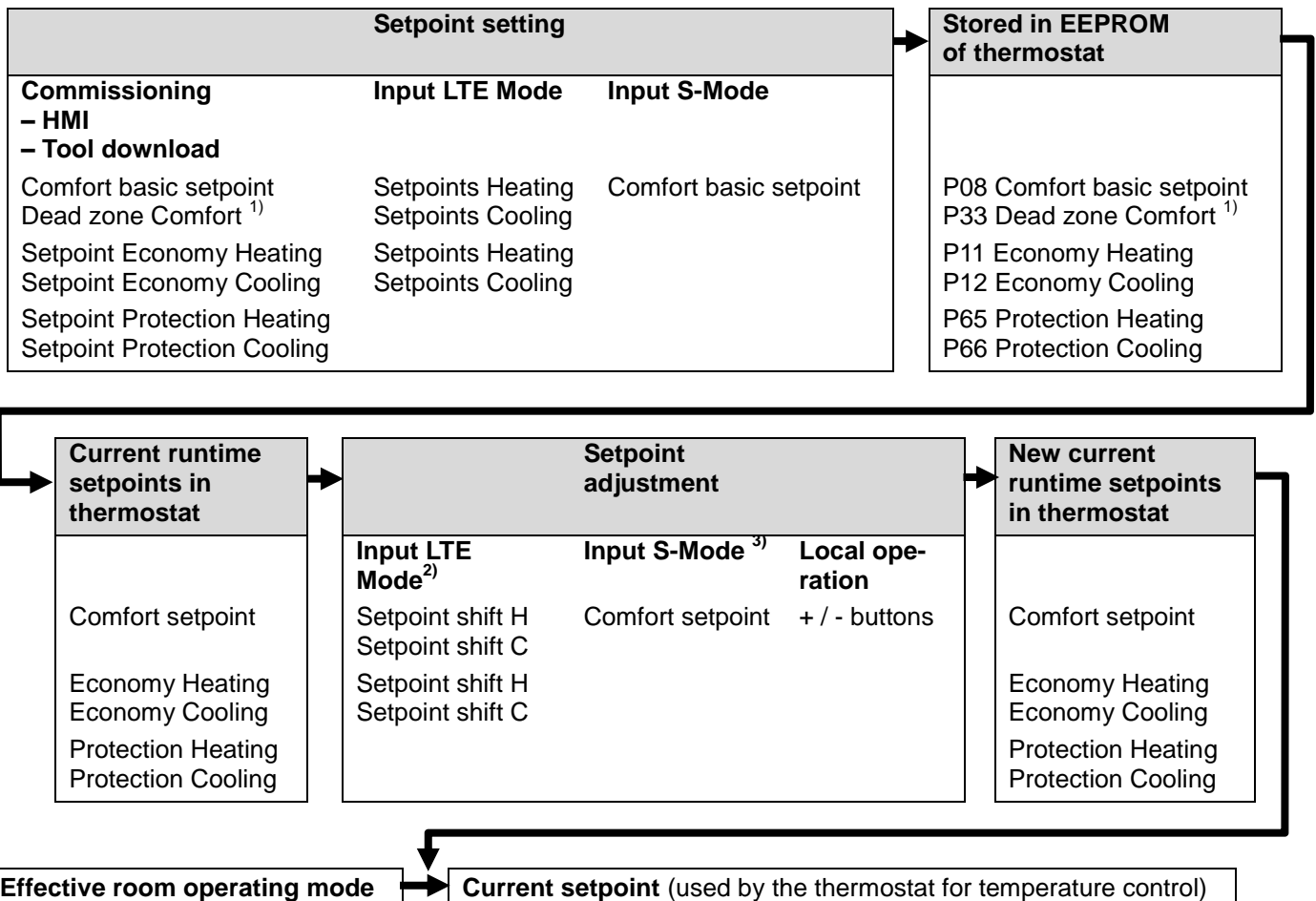

- 1) Only required for heating AND cooling applications (see section 3.6.8).
- 2) LTE Mode: **the shift is added** to the local shift.
- 3) S-Mode: **the last intervention wins**, either S-Mode input or local operation.



Current setpoint

The current setpoint (used by the thermostat for temperature control) is available on the bus for use in the central control unit.

General notes:

- The supported communication objects are different in LTE Mode and S-Mode.
- Changes via the local HMI or via tool have the same priority (last always wins).
- Setting the Comfort basic setpoint will reset the runtime Comfort setpoint to the basic setpoint.

Notes on setpoint adjustment (LTE Mode with Synco only)

- Central setpoint shift is used for summer / winter compensation in particular.
- Setpoint shift does not affect the setpoints stored in parameters P08, P11, P12, P33.
- Local shift and central shift are added together.
- Applies only to Comfort and Economy setpoints; Protection setpoints are not shifted centrally.
- The resulting (current) setpoint heating and cooling is limited by the Protection setpoint; if Protection setpoint is OFF, then minimum 5 °C and maximum 40 °C are used.
- The resulting setpoints for cooling and heating of the same operating mode have a minimum distance of 0.5 K between them.
- The result of local and central shift, together with the room operating mode, is used by the thermostat for temperature control (current setpoint).

Setpoint priority, Setpoint Master RMB (RDF600KN)

- The room thermostat always adopts the received setpoints from the controller RMB795. Thus the Comfort setpoints locally adjusted on the RDF600KN room thermostats are overwritten by the Comfort setpoints of the room group (i.e. within every 15 min).
- On RMB SW Version ≥ 2.0 it is possible to define under which circumstances the controller has to send out the setpoints:
 - Always (every 15min)
 - Not in Comfort mode
 - Only when changed
- See "Setpoint priority" and "Setpoint Master" functions on RMB795B.

Note:

- RDF600KN SW version $< V1.8$: The local Comfort setpoints are overwritten only if the RMB setpoints are changed.

3.4 Applications overview

The thermostats support the following applications, which can be configured using the DIP switches inside the front panel of the unit or a commissioning tool.

Remote configuration

All DIP switches need to be set to OFF (remote configuration, factory setting) to select an application via commissioning tool.

Remote configuration, via commissioning tool (factory set)

- Synco ACS
- ETS

DIP switches

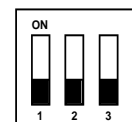

The tools provide the applications described in section 3.4.1.

For universal applications (chilled ceiling, etc.) and compressor applications, refer to section 3.6.6 and section 3.6.7.

3.4.1 Applications for fan coil systems

Application and output signal, DIP switches, diagram

- 2-pipe fan coil unit (heating or cooling)

ON/OFF

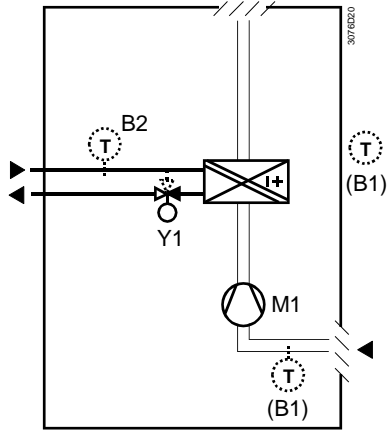
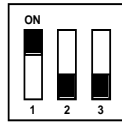

- 2-pipe fan coil unit with el. heater (heating or cooling) ON/OFF

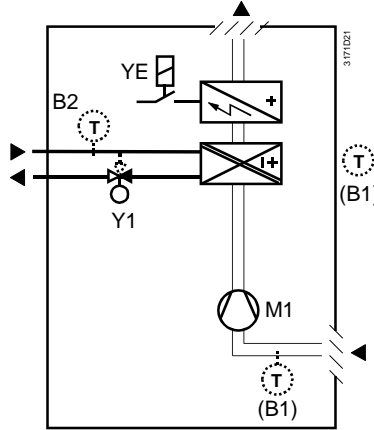
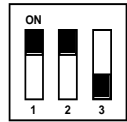

- 2-pipe fan coil unit (heating or cooling)

3-position

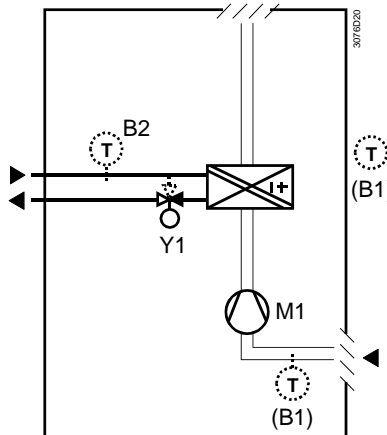
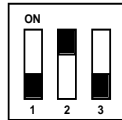

- 4-pipe fan coil unit (heating and cooling)

ON/OFF

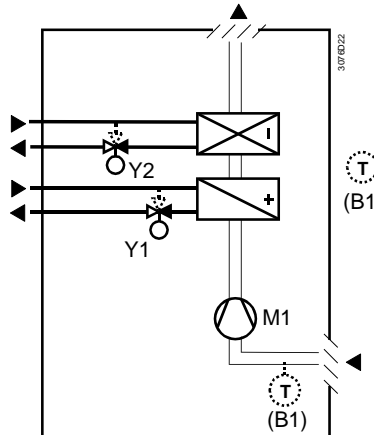
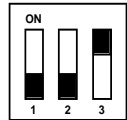

Legend

Y1 Heating or heating/cooling valve actuator
 Y2 Cooling valve actuator
 YE Electric heater
 N1 Thermostat

B1 Return air temperature sensor or external room temperature sensor (optional)
 B2 Changeover sensor (optional)
 M1 1-speed or 3-speed fan

3.4.2 Applications for Universal systems

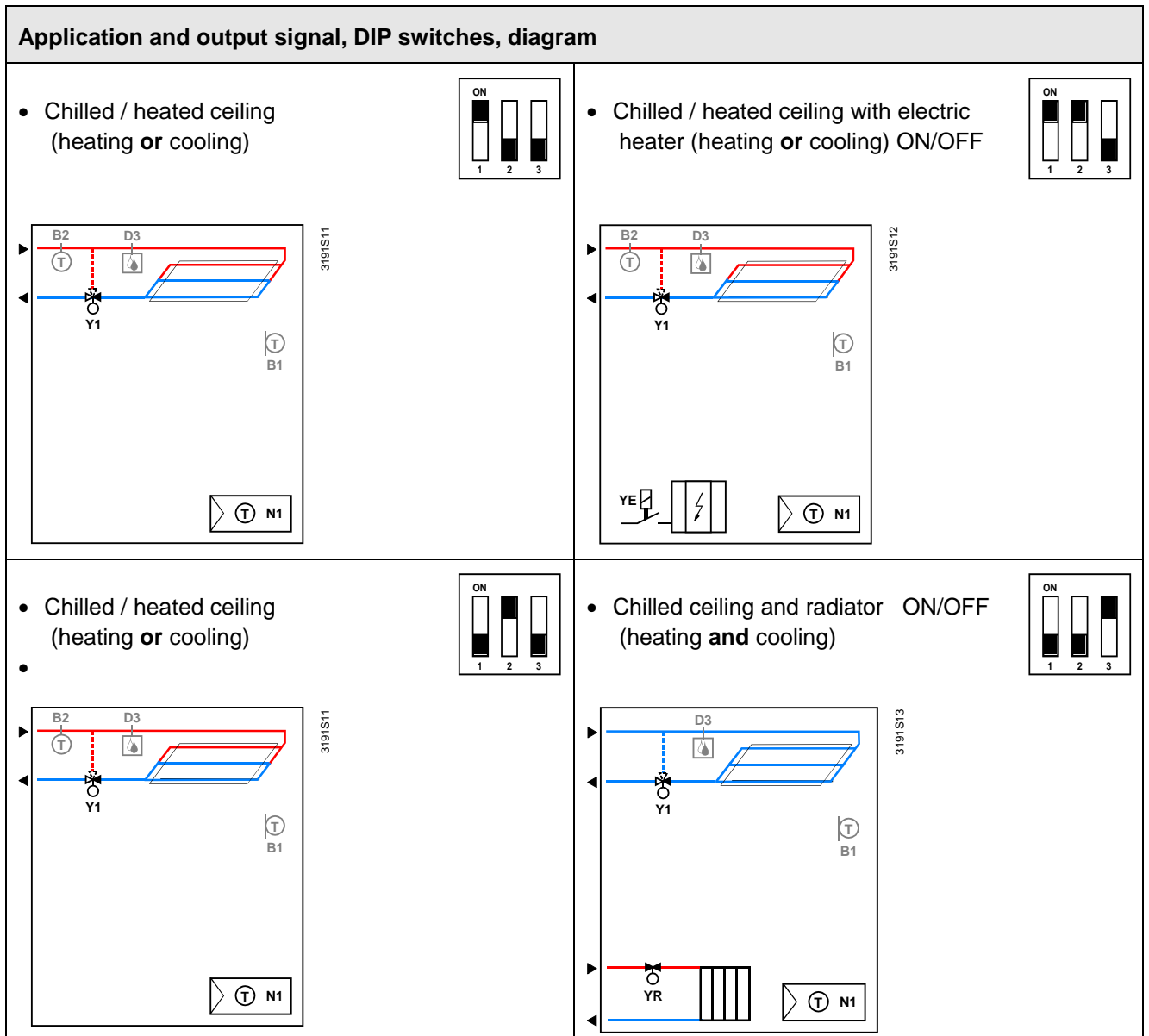

Legend

Y1 Heating or heating/cooling valve actuator
 YR Radiator valve actuator
 YE Electric heater
 N1 Thermostat

B1 Return air temperature sensor or external room temperature sensor (optional)
 B2 Changeover sensor (optional)
 M1 1-speed or 3-speed fan
 D3 Dewpoint sensor

3.4.3 Applications for heat pump systems

Application and output signal, DIP switches, diagram

- 1-stage compressor (heating **or** cooling)

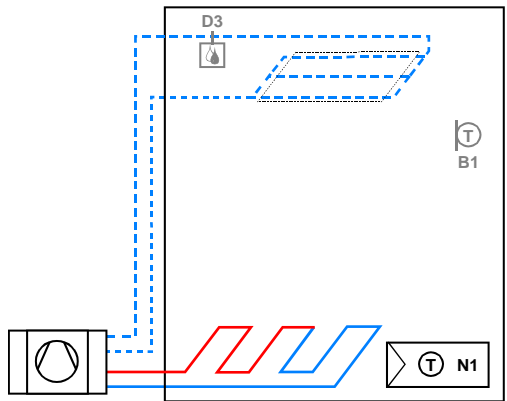
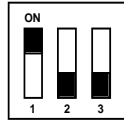

- 1-stage compressor with electric heater (heating **or** cooling) ON/OFF

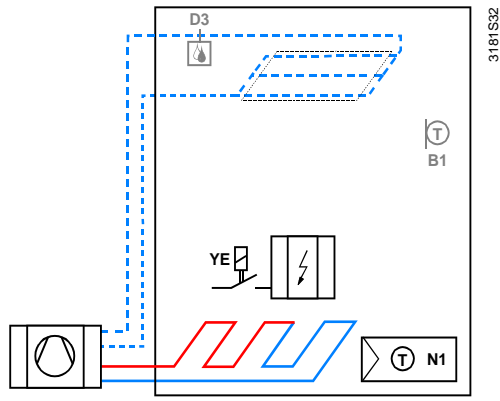
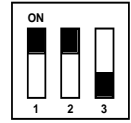

- 1-stage compressor (heating **and** cooling)

ON/OFF

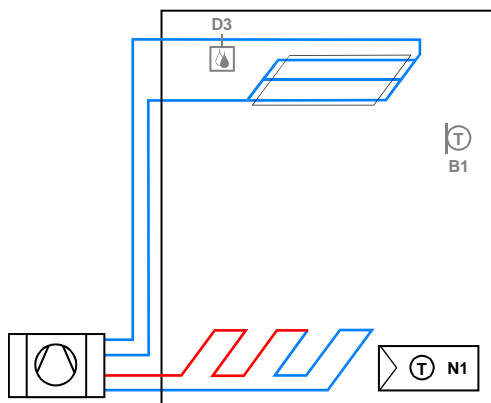
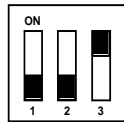

Legend

N1 Thermostat

YE Electric heater

B1 Return air temperature sensor or external room temperature sensor (optional)

D3 Dewpoint sensor

3.5 Additional functions

Heating / cooling changeover via bus



Heating/cooling changeover

The heating / cooling changeover information can be received via bus. This is only possible if the control sequence is set to automatic heating / cooling changeover (parameter P01 = 3) and no local input X1, X2 is assigned with this function.

In the absence of the required information (e.g. due to problems with data communication, power failure, etc.), the thermostat operates in the last valid room operating mode (heating or cooling).

Automatic heating / cooling changeover via changeover sensor

If a cable temperature sensor (QAH11.1 + ARG86.3) is connected to X1 / X2, and parameter P38 / P40 is = 2, the water temperature acquired by the changeover sensor is used to change over from heating to cooling mode, or vice versa. When the water temperature is above 28 °C (parameter P37), the thermostat changes over to heating mode, and to cooling mode when below 16 °C (parameter P36). If the water temperature is between the 2 changeover points immediately after power-up, the thermostat starts in the previously active mode. The water temperature is acquired at 30-second intervals and the operating state is updated accordingly.

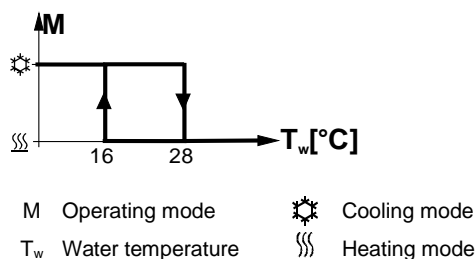

Changeover switch

The QAH11.1 cable temperature sensor for automatic heating / cooling changeover can be replaced by an external switch for manual, remote changeover:

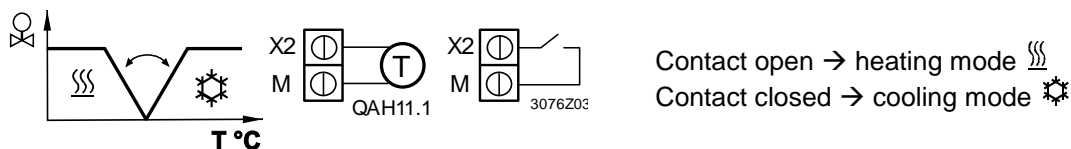

The sensor or switch can be connected to input terminal X2 or X1, depending on the commissioning of the inputs (P38, P40). See also section 3.9.

Note

By using an external switch as changeover, the Operating action (via parameters P39 or P41) cannot be modified.

The assignment is fix: Contact open → heating mode
Contact closed → cooling mode

Manual heating / cooling changeover

If manual heating / cooling changeover is commissioned (P01 = 2), then heating / cooling mode cannot be changed via bus / changeover sensor / switch; it will remain in the last mode as selected locally via button.

External / return air temperature sensor

The thermostat acquires the room temperature via built-in sensor, external room temperature sensor (QAA32), or external return air temperature sensor (QAH11.1) connected to multifunctional input X1 or X2. Inputs X1 or X2 must be commissioned accordingly. See section 3.9.

Purge function	The changeover sensor ensures changeover from heating to cooling mode based on the acquired water temperature. We recommend activating the "Purge" function (parameter P50) with 2-port valves. This function ensures correct acquisition of the medium temperature even if the 2-port valve is closed for an extended period of time. The valve is then opened for 1 to 5 minutes (adjustable) at 2-hour intervals during off hours.
Caution 	The "Purge" function (parameter P50) must be disabled if the thermostat is used in compressor-based applications.
Avoid damage from moisture	In very warm and humid climates, the fan can be run periodically or continuously at a low fan speed (e.g. in empty apartments or shops) in Economy mode by setting parameter P61, in order to avoid damage from moisture due to lack of air circulation. See also section 3.8 for "Fan kick function".
Minimum output ON-time / OFF-time	<p>Limit the ON/OFF switching cycle to protect the HVAC equipment, e.g. compressor and reduce wear and tear. The minimum output ON-time and OFF-time for 2-position control output can be adjusted from 1 to 20 minutes via parameters P48 and P49.</p> <p>The factory setting is 1 minute.</p> <p>Readjusting the setpoint or heating / cooling mode changeover immediately results in calculation of the output state; the outputs may not hold the minimum 1-minute ON/OFF time.</p> <p>If parameter P48 or P49 is set to above 1 minute, the minimum ON/OFF time for the control output is maintained as set, even if the setpoint or changeover mode is readjusted.</p>
Floor heating / Floor cooling	<p>All heating sequences can also be used for floor heating.</p> <p>You can use fan coil unit heating / cooling sequences for floor heating or cooling by disabling the fan via parameter P52.</p>
Floor temperature limitation function	<p>The floor temperature should be limited for 2 reasons: Comfort and protection of the floor.</p> <p>The floor temperature sensor, connected to multifunctional input X1 or X2, acquires the floor temperature. If the temperature exceeds the parameterized limit (parameter P51), the heating valve is fully closed until the floor temperature drops to a level 2 K below the parameterized limit.</p> <p>In case of an external sensor error, if the room temperature drops below the protection setpoint (e.g. 8 °C), the heating output of the thermostat remains disabled, until the external sensor fault is removed.</p> <p>This function is factory-set to OFF via P51 (disabled). Input X1 or X2 must be commissioned accordingly (P38 or P40 = 1). See section 3.9 .</p>
Recommended values for P51:	<p>Living rooms: Up to 26 °C for long-time presence, up to 28 °C for short-time presence.</p> <p>Bath rooms: Up to 28 °C for long-time presence, up to 30 °C for short-time presence.</p>

The table below shows the relation among parameter, temperature source and temperature display:

Parameter P51	External temp. sensor available	Source for display of room temperature	Output control according to	Floor temp. limit function	Error Handling
OFF	No	Built-in sensor	Built-in sensor	Not active	--
OFF	Yes	External temp. sensor	External temp. sensor	Not active	--
10...50 °C	No / Faulty	Built-in sensor	Heating output will be turned OFF	Not active	Display " Er3 " and heating output will be turned OFF
10...50 °C	Yes	Built-in sensor	Built-in sensor + limit by external sensor	Active	--

Note: once the fault is cleared, i.e. plug back / change to a working EXT Sensor, the thermostat should start to work again in 1-2 minutes

The "Floor temperature limitation" function influences the outputs listed in the table below:

Application	Output Y11	Output Y21	"Floor temp. limit" function has impact on			Remark
			Heating (P01 = 0/2/3)	Cooling (P01 = 1/2/3)	Heat. and cool. (P01 = 4)	
2-pipe	H/C valve		Y11	N/A		
2-pipe & el heater	H/C valve	El heater	Y21	Y21 *)		Only el heater
4-pipe	Heating valve	Cooling valve	Y11	N/A	Y11	

*) If P13 = ON → electric heater in cooling mode

Note: Either floor temperature sensor or external room temperature sensor can be used.

Dew point monitoring

Dew point monitoring is essential to prevent condensation on the chilled ceiling (cooling with fan disabled, parameter P52). It helps avoid associated damage to the building.

A dew point sensor with a potential-free contact is connected to multifunctional input X1 or X2. If there is condensation, the cooling valve is fully closed until no more condensation is detected, and the cooling output is disabled temporarily.



Fault state
Fault information

The condensation symbol "☉" is displayed during temporary override and the fault "Condensation in room" will be sent via bus.

The input must be commissioned accordingly (P38, P40).

See section 3.9.

Button lock

If the "Button lock" function is enabled by parameter P14, the buttons will be locked or unlocked by pressing the operating mode button for 3 seconds.

If "Auto lock" is configured, the thermostat will automatically lock the buttons 10 / 20 seconds after the last adjustment (RDF301... / RDF600KN).

3.6 Control sequences

3.6.1 Sequences overview (setting via parameter P01)

The main control sequence (i.e. the water coil sequence of the fan coil unit) can be set via **parameter P01**.

The following sequences can be activated in the thermostats (each without or with auxiliary heating).

The available sequences depend on the application (selected via DIP switch, see section 3.4).

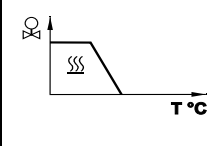
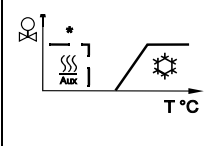
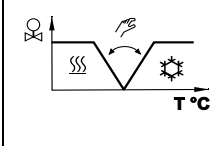
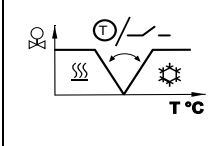
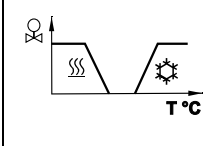
Parameter	P01 = 0	P01 = 1	P01 = 2	P01 = 3	P01 = 4
Sequence					
	Heating	Cooling *) 2-pipe with el. heater	Manually select heating or cooling sequence (using the button on the thermostat)	Automatic heating / cooling changeover via external water temperature sensor or remote switch	Heating and cooling sequence, i.e. 4-pipe
Available for basic application ¹⁾ : ↓					
2-pipe, 2-pipe & el heater	✓	✓	✓	✓	
4-pipe			✓ ²⁾	✓ ²⁾	✓

Note: ¹⁾ For chilled / heated ceiling and radiator applications, see section 3.6.6; for compressor applications, see section 3.6.7.

- ²⁾ For manual and automatic changeover with 4-pipe applications, see section 3.6.5:
- 4-pipe **manual** changeover (P01 = 2) means activating either cooling or heating outputs.
 - 4-pipe **automatic** changeover (P01 = 3) means swapping the control outputs according to a heating / cooling sensor or remote switch ("main and secondary" application), see section 3.6.5.

For the relation between setpoints and sequences, see section 3.6.8.

3.6.2 Application mode



Application mode

The behavior of the thermostat can be influenced by a building automation and control system (BACS) via bus with the command "Application mode". With this signal, cooling and/or heating activity can be enabled or disabled. Application mode is supported in LTE Mode and S-Mode.

The RDF KNX thermostats support the following commands:

#	Application mode	Description	Control sequence enabled
0	Auto	Thermostat automatically changes between heating and cooling	Heating and/or cooling
1	Heat	Thermostat is only allowed to heat	Heating only
2	Morning warm-up	If "Morning warm-up" is received, the room should be heated up as fast as possible (if necessary). The thermostat will only allow heating	Heating only
3	Cool	Thermostat is only allowed to provide cooling	Cooling only
4	Night purge	Not supported by fan coil applications	N/A (= Auto)
5	Pre-cool	If "Pre-cool" is received, the room should be cooled down as fast as possible (if necessary). The thermostat will only allow cooling	Cooling only
6	OFF	Thermostat is not controlling the outputs, which means all outputs go to off or 0%	Neither heating nor cooling
8	Emergency heat	The thermostat should heat as much as possible. The thermostat will only allow heating	Heating only
9	Fan only	All control outputs are set to 0% and only the fan is set to high speed. Function will be terminated by any operation on the thermostat	Run fan in high speed

With all other commands, the thermostat behaves like in Auto mode, i.e. heating or cooling according to demand.



The state (heating or cooling) of the thermostat can be monitored with the ACS tool (diagnostic value "Control sequence"). The last active mode is displayed when the thermostat is in the dead zone or temperature control is disabled.

Heating OR cooling

With a 2 pipe application, the control sequence state is determined by the application mode (see section 3.6.3) and by the state of the heating / cooling changeover signal (via local sensor or bus), or fixed according to the selected control sequence (P01 = heating (0) / cooling (1)).

Application mode (via bus)	State changeover / continuous heating or cooling	Control sequence state
Auto (0)	Heating	Heating
	Cooling	Cooling
Heat (1), (2), (8)	Heating	Heating
	Cooling	Heating
Cool (3), (5)	Heating	Cooling
	Cooling	Cooling
Night purge (4), Fan only (9)	Heating	Heating
	Cooling	Cooling

Heating AND cooling

With a 4-pipe, 2-pipe with electric heater, and 2-pipe with radiator application, the control sequence state depends on the application mode and on the heating / cooling demand.

Application Mode (via bus)	Heating / cooling demand	Control sequence state
Auto (0)	Heating	Heating
	No demand	Heating / cooling depending on last active sequence
	Cooling	Cooling
Heat (1), (2), (8)	Heating	Heating
	No demand	Heating
	Cooling	Heating
Cool (3), (5)	Heating	Cooling
	No demand	Cooling
	Cooling	Cooling
Night purge (4), Fan only (9)	No temperature control active	Heating / cooling depending on last active sequence

The value of the output as a function of the room temperature is shown in the following diagram in case of a heating and cooling system:

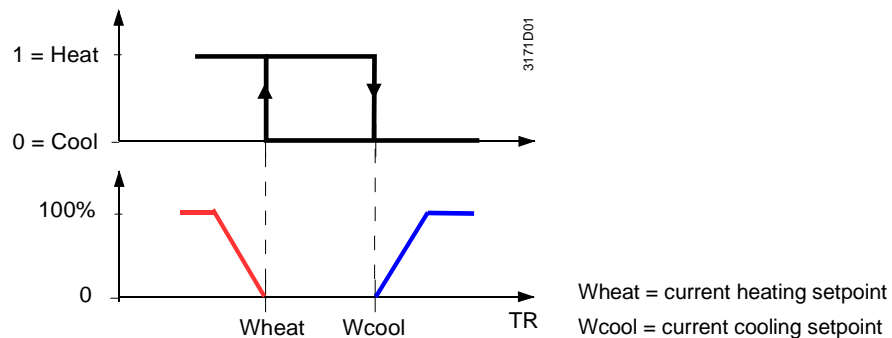

3.6.3 2-pipe fan coil unit

On 2-pipe applications, the thermostat controls a valve in heating / cooling mode with changeover (automatically or manually), heating only, or cooling only. Cooling only is factory-set (P01 = 1).

ON/OFF control

Control sequence
ON/OFF output

The diagrams below show the control sequence for 2-position control.

Heating mode

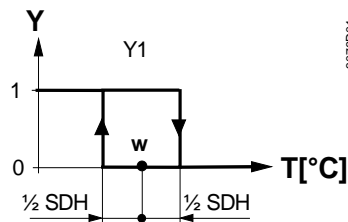

Cooling mode

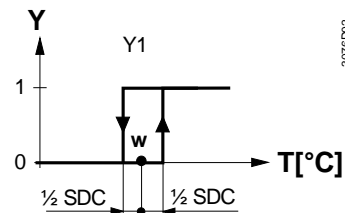

T[°C] Room temperature
w Room temperature setpoint
Y1 Control command "Valve" or "Compressor"

SDH Switching differential "Heating" (P30)
SDC Switching differential "Cooling" (P31)

Modulating control: 3-position

Control sequence
modulating output

The diagrams below show the control sequence for modulating PI control.

Heating mode

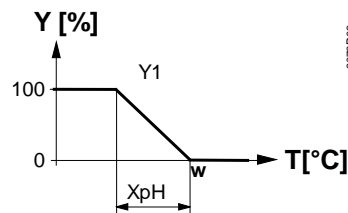

Cooling mode

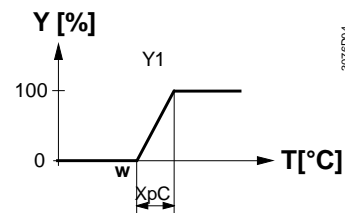

T[°C] Room temperature
w Room temperature setpoint
Y1 Control command "Valve"

XpH Proportional band "Heating" (P30)
XpC Proportional band "Cooling" (P31)

- Notes:
- The diagrams only show the PI thermostat's proportional part.
 - For the fan sequence see section 3.8.

Setting the sequence and the control outputs

Refer to section 3.4, section 3.6.1 and section 3.7.

3.6.4 2-pipe fan coil unit with electric heater

Heating or cooling with auxiliary heater

On 2-pipe applications with electric heater, the thermostat controls a valve in heating / cooling mode with changeover, heating only, or cooling only plus an auxiliary electric heater.

Cooling only is factory-set (P01 = 1) with enabled electric heater (P13).

Electric heating, active in cooling mode

In cooling mode, the valve receives an **OPEN** command if the acquired temperature is above the setpoint.

The electric heater receives an **ON** command if the acquired room temperature drops below "setpoint" minus "dead zone" (= setpoint for electric heater) while the electric heater is enabled (parameter P13 = ON).

Note: "Setpoint for electric heater" is limited by parameter "Maximum setpoint for Comfort mode" (P10).

Electric heating in heating mode

In heating mode, the valve receives an **OPEN** command if the acquired temperature is below the setpoint. The electric heater is used as an additional heating source when the heating energy controlled by the valve is insufficient.

The electric heater receives an **ON** command, if the temperature is below "setpoint" minus "setpoint differential" (= setpoint for electric heater).

Electric heating and manual changeover

The electric heater is active in heating mode only and the control output for the valve is permanently disabled when manual changeover is selected (P01 = 2).

Digital input "Enable electric heater"

Remote enabling / disabling of the electric heater is possible via input X1 or X2 for tariff regulations, energy savings, etc.

Input X1 or X2 must be commissioned accordingly (parameters P38, P40). See section 3.9.



Enable electric heater

The electric heater can also be enabled / disabled via bus.

Note: If "Enable electric heater" input is used via bus, then the function **must not** be assigned to a local input X1 or X2.



Caution An electric heater must always be protected by a safety limit thermostat!

ON/OFF control

Control sequence
ON/OFF output

The diagrams below show the control sequence for 2-position.

Heating mode

(automatic changeover = heating or heating only)

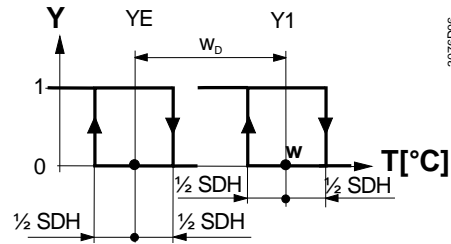

Cooling mode

(man. / auto. changeover = cooling or cooling only)

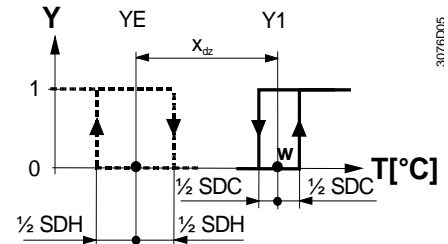

Heating mode with manual changeover (P01 = 2) (manual changeover = heating)

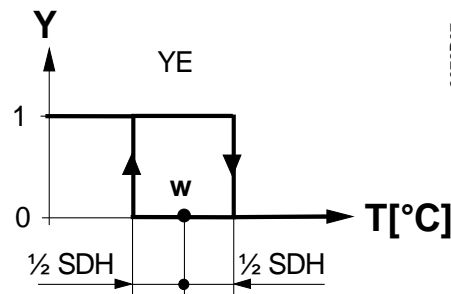

T [°C]	Room temperature
W	Room temperature setpoint
Y1	Control command "Valve" or "Compressor"
YE	Control command "Electric heater"
SDH	Switching differential "Heating" (P30)
SDC	Switching differential "Cooling" (P31)
X _{dz}	Dead zone (P33)
W _D	Setpoint differential (P34)

- Note:
- The diagrams only show the PI thermostat's proportional part.
 - For the fan sequence see section 3.8.
 - For better temperature control performance with 2-pos electric heater, we suggest to set the switching differential heating (P30) to 1K.

Setting the sequence and the control outputs

Refer to section 3.4, section 3.6.1, and section 3.7.

3.6.5 4-pipe fan coil unit

Heating and cooling

On 4-pipe applications, the thermostat controls 2 valves in heating and cooling mode, heating / cooling mode by manual selection, or heating and cooling mode with changeover. Heating and cooling mode (P01 = 4) is factory-set.

4-pipe application with manual changeover

The heating or cooling output can be released via operating mode button if parameter P01 is set to Manual (P01 = 2).

"Main and secondary" application (4-pipe with changeover)

If parameter P01 is set to changeover (P01 = 3), the heating and cooling output is swapped according to the input state of the changeover sensor / switch / bus input (see automatic heating and cooling changeover sensor in section 3.5). This mode is used for the so-called "Main and secondary" application. This is a 4-pipe fan coil unit system with different capacities of the 2 coils. The water circuit is changed to optimize the energy exchange depending on the season (summer / winter):

- Winter: Large coil (V1) for heating, small coil (V2) for cooling.
- Summer: Large coil (V1) for cooling, small coil (V2) for heating.

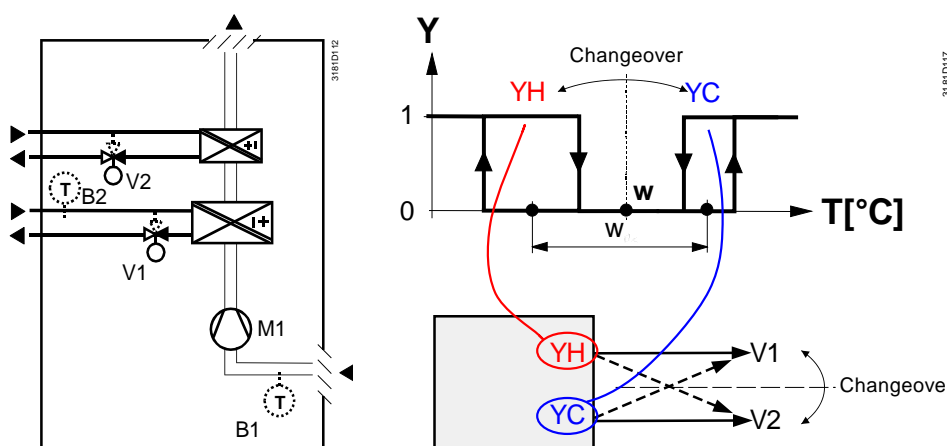

Note:
This example shows ON/OFF control; for modulating control, connect the appropriate output terminals

- Note:
- The parameter for the heating and cooling changeover sensor (B2 in the above diagram) must be set to 2 (X1 or X2, P38 or P40).
 - The thermostat assumes winter operation when $B2 > P37$ (factory setting 28 °C).
 - The thermostat assumes summer operation when $B2 < P36$ (factory setting 16 °C).

ON/OFF control

The diagrams below show the control sequence for 2-position control.

Heating mode with manual selection
(P01 = 2)

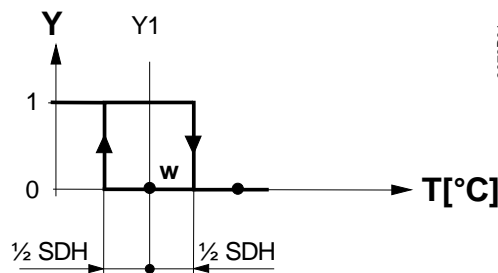

Cooling mode with manual selection
(P01 = 2)

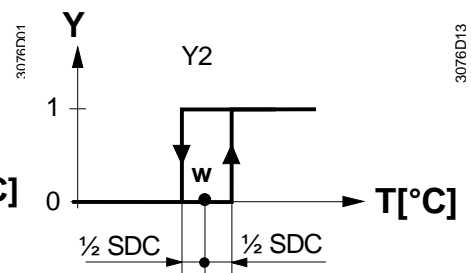

Heating and cooling mode (P01 = 04)

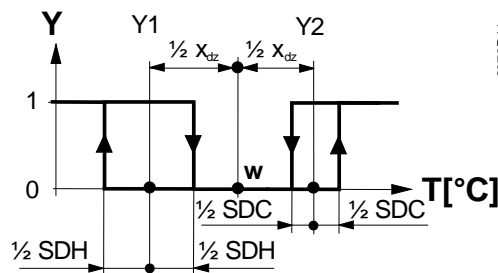

- T [°C] Room temperature
- w Room temperature setpoint
- Y1 Control command "Valve" or "Comp." (H)
- Y2 Control command "Valve" or "Comp." (C)
- SDH Switching differential "Heating" (P30)
- SDC Switching differential "Cooling" (P31)
- X_{dz} Dead zone (P33)

- Note:
- The diagrams only show the PI thermostat's proportional part.
 - For the fan sequence see section 3.8.

Setting the sequence and the control outputs

Refer to section 3.4, section 3.6.1, and section 3.7.

3.6.6 Chilled / heated ceiling and radiator applications

For chilled / heated ceiling and radiator,

- set the corresponding basic application
- disable the fan (P52)

The following applications are available:

Application for chilled / heated ceiling, radiator	Set basic application	See section	Sequences
Chilled / heated ceiling with changeover	2-pipe	3.6.3	H (\) C (/)
Chilled / heated ceiling & el heater (cooling only: disable el heater via P13)	2-pipe and electric heater	3.6.4	El H + H (/ \) El H + C (/ /) C (/)
Chilled ceiling and radiator	4-pipe	3.6.5	H + C (\ /)

3.6.7 Compressor applications

For compressor applications,

- set the corresponding basic application
- disable the fan (P52) or set the fan speed (P53)

The following applications are available:

Application for compressor	Set basic application	See section	Sequences
1-stage compressor for heating or cooling	2-pipe	3.6.3	H (\) C (/)
1-stage compressor and electric heater <i>(for cooling only: disable electric heater via P13)</i>	2-pipe and electric heater	3.6.4	EI H + H (\) EI H + C (/) C (/)
1-stage compressor for heating and cooling	4-pipe	3.6.5	H + C (\ /)

- Note:
- Minimum ON/OFF time: P48 / P49
 - Fan operation: P52 (0 = disabled, 1 = enabled)
 - Fan speed: P53 (1 = 1-speed, 2 = 3-speed)

3.6.8 Setpoints and sequences

2-pipe applications

On changeover applications, the Comfort setpoints for heating and cooling sequence are the same (w).

On 2-pipe applications with electric heater, the Comfort setpoint is either at the first heating sequence (in heating mode) or at the cooling sequence (in cooling mode).

The setpoints for Economy and Protection mode are below the Comfort setpoints (heating) and above the Comfort setpoints (cooling).

They can be set via parameters P11, P12 (Economy mode) and P65, P66 (Protection mode).

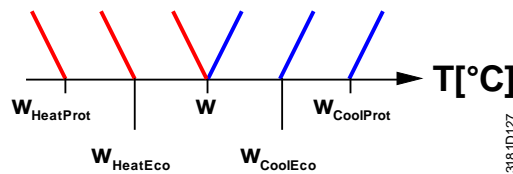

Application	Comfort mode		Economy / Protection mode	
	Heating	Cooling	Heating	Cooling
2-pipe				
2-pipe and electric heater				

1) If P13 = ON

2) In case of manual changeover (P01 = 2), the first heating sequence is disabled to prevent heating (electric heater) and cooling (coil) at the same time

W = setpoint in Comfort mode

$W_{HeatEco/Prot}$ = setpoint heating in Economy or Protection mode

$W_{CoolEco/Prot}$ = setpoint cooling in Economy or Protection mode

YR = radiator sequence

YE = electric heater sequence

4-pipe applications

On 4-pipe applications, the Comfort setpoint (w) is in the middle of the dead zone, between the heating and cooling sequence.

The dead zone can be adjusted via parameter P33.

If manual changeover is selected, then either the cooling sequence or the heating sequence is released. In this case, the Comfort setpoint is at the selected heating or cooling sequence.

Application	Comfort mode			Economy / Protection mode Heating and/or cooling
	Heating and cooling	Heating only ¹⁾	Cooling only ¹⁾	
4-pipe				

1) Manual changeover, P01 = 2

W = setpoint in Comfort mode

$W_{\text{HeatEco/Prot}}$ = heating setpoint for Economy or Protection mode

$W_{\text{CoolEco/Prot}}$ = cooling setpoint for Economy or Protection mode

YE = electric heater sequence

3.7 Control outputs

3.7.1 Overview

Overview of control outputs

Different control output signals are available. They need to be defined during commissioning (see below).

Control output / Product no.	2-position	2-position PWM	3-position	DC 0...10 V
RDF301, RDF301.50, RDF301.50H, RDF600KN	Y11, Y21 (2 x SPST)	---	Y11, Y21 *) (1 x ▲ / ▼)	---

*) Only on 2-pipe application

Note: In the ACS tool, Y11 and Y21 are called Y1 and Y2.

ON/OFF control signal (2-position)

The valve or compressor receives the **OPEN/ON** command via control output Y11 or Y21 when...

1. the acquired room temperature is below the setpoint (heating mode) or above the setpoint (cooling mode).
2. the control outputs have been inactive for more than the "Minimum output OFF-time" (factory setting 1 minute, adjustable via parameter P48).

OFF command when...

1. the acquired room temperature is above the setpoint (heating mode) or below the setpoint (cooling mode).
2. the valve has been active for more than the "Minimum output on-time" (factory setting 1 minute, adjustable via parameter P49).

Electric heater control signal (2-position)

The electric heater receives an **ON** command via the auxiliary heating control output (Y..., see Mounting Instructions) when...

1. the acquired room temperature is below the "Setpoint for electric heater"
2. the electric heater has been switched off for at least 1 minute.

The **OFF** command for the electric heater is output when...

1. the acquired room temperature is above the setpoint (electric heater)
2. the electric heater has been switched on for at least 1 minute.

Caution

A safety limit thermostat (to prevent overtemperatures) must be provided externally.

Adaptive temperature compensation for electric heater (RDF600KN)

When an electric heater is connected directly to the ON/OFF Y21, the current causes the relay contact to heat up. This falsifies the reading of the internal temperature sensor. The thermostat compensates the temperature if the rated current/power of the electric heating is entered in the parameters.

P45 (load current el. Heater): Factory setting 0kW, setting range: 0.0...1.2 kW.

3-position control signal

Output Y11 provides the **OPEN** command, and Y21 the **CLOSE** command to the 3-position actuator.

The factory setting for the actuator's running time is 150 seconds. It can be adjusted via parameter P44.

The parameter is only visible if 3-position is selected via DIP switches.

Synchronization

1. When the thermostat is powered up, a closing command for the actuator running time + 150% is provided to ensure that the actuator fully closes and synchronizes to the control algorithm.
2. When the thermostat calculates the positions "fully close" or "fully open", the actuator's running time is extended + 150% to ensure the right actuator position is synchronized to the control algorithm.
3. After the actuator reaches the position calculated by the thermostat, a waiting time of 30 seconds is applied to stabilize the outputs.

3.7.2 Control outputs configuration (setting via DIP switches or tool)

The type of the control outputs on 2-pipe applications (2- or 3-position) is set via DIP switches (see section 3.4).

The DIP switches have no impact if the application is commissioned via tool. Control outputs need to be set via ACS in this case.

Note: In the tool, the parameter is called "Output Y1 / Y2", not Y11 / Y2.

3.8 Fan control

The fan operates in automatic mode or at the selected speed with manual mode. In automatic mode, the fan speed depends on the setpoint and the current room temperature. When the room temperature reaches the setpoint, the control valve closes and the fan switches off or stays at fan speed 1 according to the setting of parameters P15 (fan stage in dead zone Comfort on RDF600KN) and P60 (fan kick).

Factory setting for "Fan in the dead zone":

- RDF600KN: Fan speed OFF: (P15 = 0, P60 = OFF)
- RDF301...: Fan speed 1 (P60 = 0)

Note: P15 is not implemented into RDF600KN SW version < V1.8.

The fan speed and mode can be changed via bus.

For this purpose, the fan command value needs to be enabled.



Fan command value
Enable fan command value



Fan operation
Fan stage 1-2-3
Fan output

3-speed fan control with modulating heating / cooling control

The fan speed and mode can be monitored via bus.

The individual switching points for **ON** of each fan stage can be adjusted via control parameters P55...P57. The fan speed switch off point is 20% below the switch on point. The diagrams below show fan speed control for modulating PI control.

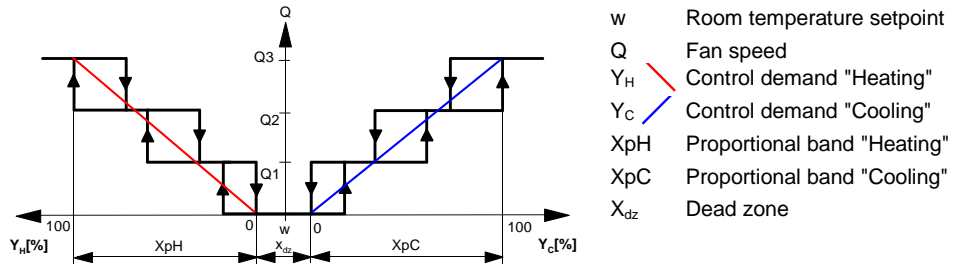

Note: The diagram only shows the PI thermostat's proportional part.

3-speed fan control with ON/OFF heating / cooling control

On applications with 2-position control:

- 1) The switching point for low fan speed (Q1) is synchronized to the heating / cooling output. Parameter "Switching point fan speed low" P57 is not relevant.
- 2) The maximum switching range of the fan (X_{pH_{Fan}} / X_{pC_{Fan}}) is defined by the switching differential (SDH/SDC) via a look-up table.

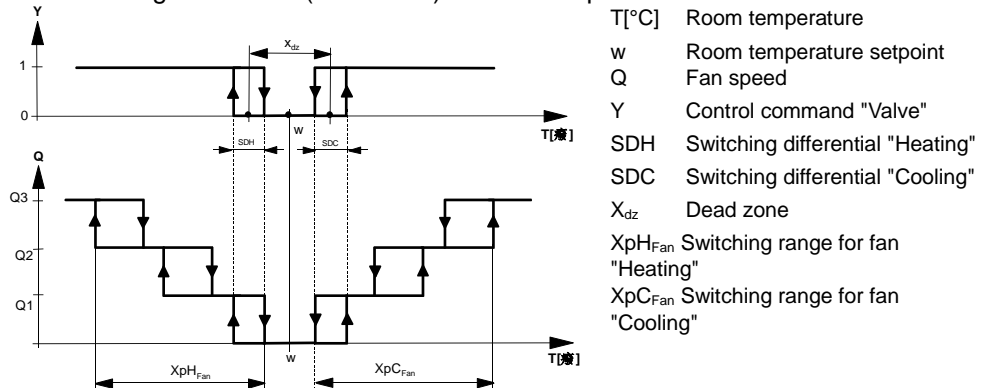

Look-up table with ON/OFF control

SDH/SDC [K]	0.5	1.0	1.5	2.0	2.5	3.0	3.5	4.0	>4.5
XpH _{Fan} /XpC _{Fan} [K]	2	3	4	5	6	7	8	9	10

1-speed / 3-speed fan

The thermostat can control a 1- or 3-speed fan (selected via control parameter P53). A 1-speed fan is connected to terminal Q1, a 3-speed fan to terminals Q1, Q2 and Q3.

Fan operation as per heating / cooling mode, or disabled

Fan operation can be limited to be active with cooling only or heating only, or even be totally disabled via control parameter "Fan operation" P52. When fan operation is disabled, the fan symbol on the display disappears and pressing the fan button has no impact. This function allows you to use the thermostat on universal applications such as chilled / heated ceilings and radiator, etc. (see section 3.6.6).

Fan minimum on-time

In automatic mode, a dwelling time of 2 minutes (factory setting) is active. The fan maintains each speed for at least 2 minutes before it changes to the next speed. This minimum on-time can be adjusted from 1...6 minutes via parameter P59.

Fan operation in dead zone (fan kick)

In automatic fan mode and with the room temperature in the dead zone, the control valve is normally closed and the fan disabled. With the "Fan kick" function, the fan can be released from time to time at low speed for minimum on-time (see above) even if the valve is closed.

This function can be used to avoid damage from moisture due to a lack of air circulation, or to allow a return air temperature sensor to acquire the correct room temperature.

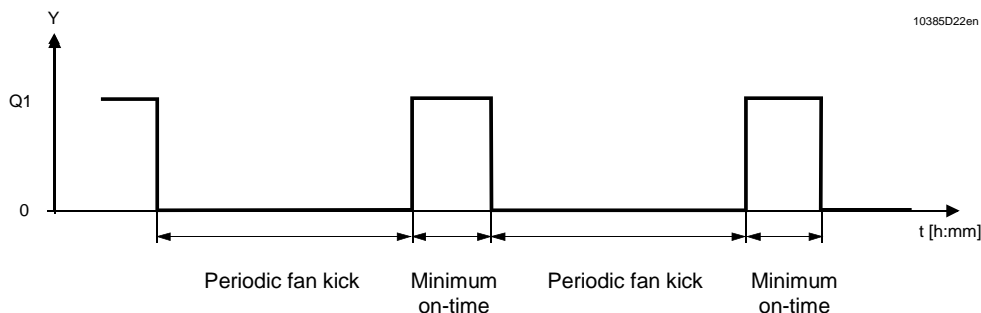

The periodic fan kick time can be selected individually for Comfort mode via parameter P60, and for Economy mode via parameter P61.

Note: Fan kick value "0" means the fan runs continuously in the dead zone. Fan kick value "OFF" means the fan does not run in the dead zone.

Fan operation in dead zone P15, Comfort mode (RDF600KN)

Via parameter P15 in "Service Level", the fan speed in the dead zone (in Comfort mode) can be set according to customer preference. The following options are available:

- Fan does not run in the dead zone (P15=0),
- Fan runs at low speed in Heating and Cooling mode (P15=1)
- Fan runs at low speed in Cooling mode only (P15=2).

The functions "Fan in dead zone" (P15) and "Fan kick" (P60) are combined as follows:

- P60 = 0 Fan runs continuously in the dead zone, P15 has no influence
- P60 = OFF Fan operation in dead zone according to P15.

Note: P15 is not implemented into RDF600KN SW version < V1.8.

Fan start

When the fan starts from standstill, it starts at speed 3 for 1 second to ensure safe fan motor start by overcoming inertia and friction (selected via parameter P58).

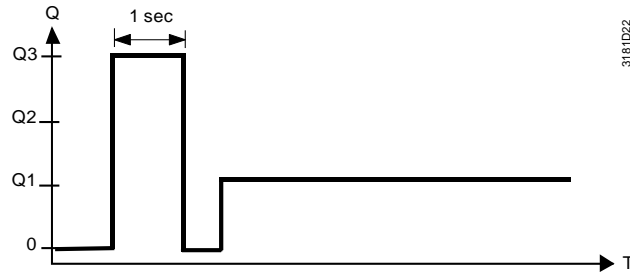

Fan overrun for electric heater

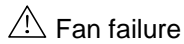

When the electric heater is switched off, the fan overruns for 60 seconds (parameter P54) to avoid overtemperature of the electric heater or prevent the thermal cutout from responding.

In case of fan failure, the thermostat cannot protect the electric heater against overtemperature. For this reason, the electric heater must feature a separate safety device (thermal cutout).

Clean fan filter reminder



Fault information

The "Clean fan filter reminder" function counts the fan operating hours and displays message "FIL  " to remind the user to clean the fan filter as soon as the threshold is reached. This does not impact the thermostat's operation, which continues to run normally. The function is set via parameter P62 (default = OFF (0)).

The "Clean filter reminder" is reset when the operating mode is manually set to Protection and back.

Fan in Auto Timer mode

In Auto Timer mode , the default fan mode is automatic. The fan mode can be changed to Manual by pressing the FAN button. The fan returns to the automatic default mode after each switchover from Comfort to Economy mode, and vice versa.

Fan start delay (RDF600KN)

To let the heating / cooling coil reach its temperature, the fan start can be delayed by a time period set via parameter P67.

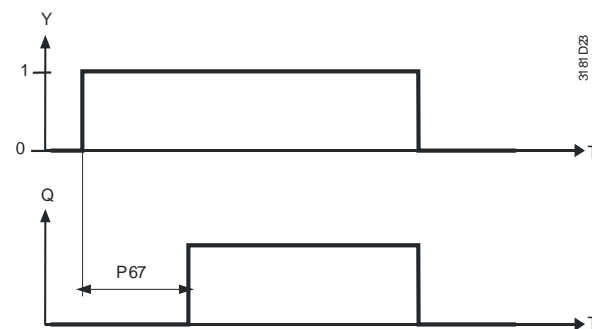

Note: This function (via parameter P67) is not implemented into RDF600KN SW version < V1.8.

3.9 Multifunctional input, digital input

The thermostat has 2 multifunctional inputs X1 and X2.

An NTC type sensor like the QAH11.1 (AI, analog input) or a switch (DI, digital input) can be connected to the input terminals. The functionality of the inputs can be configured via parameters P38 + P39 for X1 and P40 + P41 for X2.



The current temperature or state of the inputs X1/X2 is available on bus for monitoring purposes.

The parameters can be set to the following values:

#	Function of input	Description	Type X1/X2
0	Not used	No function.	--
1	External / return air temperature	Sensor input for external room temperature sensor or return air temperature sensor to acquire the current room temperature, or floor heating temperature sensor to limit the heating output. <i>Note:</i> The room temperature is acquired by the built-in sensor if the floor temperature limitation function is enabled via parameter P51.	AI
2	Heating / cooling changeover	Sensor input for "Automatic heating / cooling changeover" function. A switch can also be connected rather than a sensor Important: Switch closed means always cooling, (this cannot be changed), see section 3.5. Heating / cooling changeover is also possible via bus. In this case, the function must not be assigned to any local input X1, X2. See also section 3.5. Diagnostic value 00 is displayed for closed contact / 100 for open contact, if a switch is connected.	AI / DI
3	Window contact (RDF600KN) ¹⁾	Window contact input to switch the operating mode to Protection. If the window contact is open, user operations are ineffective and "OFF" is displayed. Window contact is also possible via bus. In this case, the function must not be assigned to any local input X1, X2. See also section 3.2.1.	DI
3	Operating mode switchover (RDF301..)	Digital input to switch over the operating mode to Economy. If the operating mode switchover contact is active, user operations are ineffective and "OFF" is displayed. Operating mode switchover is also possible via bus. In this case, the function must not be assigned to any local input X1, X2. See also section 3.2.1.	DI
4	Dew point monitor	Digital input for a dew point sensor to detect condensation. Cooling is stopped if condensation occurs.	DI



Heating/
cooling
changeover



Window
state
(RDF600..)



Window
state
(RDF301..)

Enable electric heater

Fault information

X1, X2 (Digital)

X1, X2 (Temp.)

Presence detector (RDF600...)

#	Function of input	Description	Type X1/X2
5	Enable electric heater	Digital input to enable / disable the electric heater via remote control. Enable electric heater is also possible via bus. In this case, the function must not be assigned to any local input X1, X2. See also section 3.6.	DI
6	Fault	Digital input to signal an external fault (example: dirty air filter). If the input is active, "ALx" is displayed and a fault is sent on the bus. See also section 3.11.8. (Alarm x, with x = 1 for X1, x = 2 for X2). <i>Note:</i> Fault displays have no impact on the thermostat's operation. They merely represent a visual signal.	DI
7	Monitor input (Digital)	Digital input to monitor the state of an external switch via bus, e.g. to send a local alarm via KNX to the central controller.	DI
8	Monitor input (Temperature)	Sensor input to monitor the state of an external sensor (e.g. QAH11.1) via bus, e.g. to send a local temperature (0...49°C) via KNX to the central controller.	AI
10	Presence detector (RDF600KN) ¹⁾	Standard presence: Presence detector input to switch the operating mode to Comfort in case of occupancy and back to Economy when the room is unoccupied. Hotel presence: Presence detector input to change the operating mode from Economy during unoccupied periods to the previous mode (operating mode selected by either hotel guests via local HMI or sent via bus) for occupancy and return to Economy when the room is unoccupied. Presence detector is also possible via bus. In this case, the function must not be assigned to any local input X1, X2. See also section 3.2.1.	DI

- Operational action can be changed between normally open (NO) and normally closed (NC) via parameter P39, P41.
- Each input X1 or X2 must be configured with a different function (1...5, 10). Exception: 1 or 2 inputs can be configured as fault (6) or monitor input (7, 8).
- X1 is factory-set to "Operating mode switchover" / "Window contact" (3), X2 to "External sensor" (1).

Note ¹⁾: RDF600KN SW version < V1.8 works like RDF301... with the operating mode switchover contact as window contact or presence detector.

For more detailed information, refer to section 3.4.

3.10 Handling faults

Temperature out of range

When the room temperature is outside the measuring range, i.e. above 49 °C or below 0 °C, the temperature value will blink at the limit values, i.e. "0 °C" or "49 °C". After the temperature returns to within the measuring range, the thermostat will continue to work.

For heating application, the heating output will be turned on when the temperature drops below the limit value, provided the Protection mode setpoint is not set to Off.

The cooling output in cooling applications will be turned off when the temperature exceeds the limit value, provided the Protection mode setpoint is not set to Off.

No output is activated if protection mode setpoint is set to Off.

Fault "Er1" on display

When the built-in sensor fails and no external sensor is connected, the thermostat shows the fault message "Er1" on the display. The thermostat needs to be replaced.

Fault "Er2" on display

When the internal non-volatile memory has error, e.g. unable to read or write, the thermostat shows the fault message "Er2" on the display. If it is only data corruption in the memory, a master reset can fix this error. Otherwise, the thermostat is defective and need to be replaced.

Fault "Er3" on display

When the external sensor is selected for floor temperature limitation (P51 ≠ OFF) and is not working properly, e.g. faulty or sensor is missing, the thermostat shows the fault message "Er3" on the display.

The heating output turns off immediately to ensure safety and avoid overheating of the floor. The room temperature measured by internal sensor continues to be shown on the LCD display.

Note:

- 1) Er1 has a higher display priority than Er2.
- 2) Once the external sensor fault is removed, the thermostat returns to normal working mode.



For fault status messages on the bus, see section 3.11.8.

Power failure

In the event of a power failure, all working conditions (operating mode, setpoint, fan stage, all control parameter settings) are stored without time limitation. When power returns, the thermostat reloads this data and continues to work in the same conditions as before.

3.11 KNX communications

The RDF KNX thermostats support communications as per the KNX specification.

S-Mode Standard mode; engineering via group addresses.

LTE Mode Logical Tag Extended mode, for easy engineering, is used in conjunction with Synco.

3.11.1 S-Mode

This mode corresponds to KNX communications.

Connections are established via ETS by assigning communication objects to group addresses.

3.11.2 LTE Mode

LTE Mode was specifically designed to simplify engineering. Unlike with S-Mode, there is no need to create the individual connections (group addresses) in the tool. The devices autonomously establish connections.

Definitions

To make this possible, the following circumstances are predefined:

- Every device or subdevice is located within a zone
- Every data point (input or output) is assigned to a zone
- Every data point (input or output) has a precisely defined "name".

Whenever an output and an input with the same "name" are located in the same zone, a connection is established automatically, as shown in the following diagram.

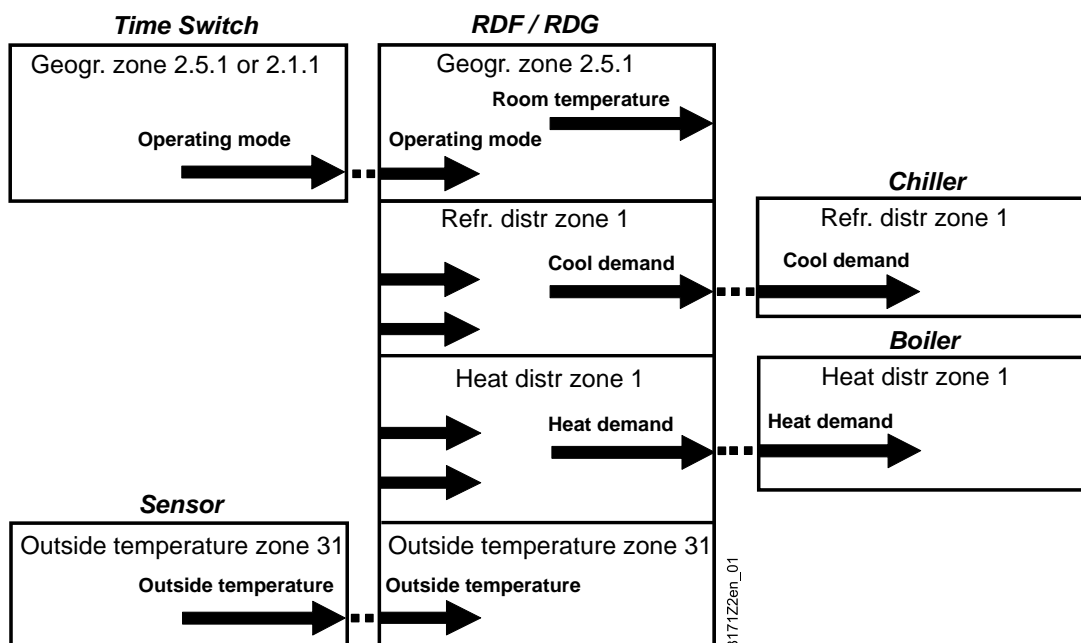

- For a detailed description of KNX (topology, bus supply, function and setting of LTE zones, filter tables, etc.), see "Communication via the KNX bus for Synco 700, 900 and RXB/RXL, Basic Documentation" [6].
- LTE Mode data points and settings are described in the Synco Application Manual [12].
- To engineer and commission a specific system, use the Synco700 planning and commissioning protocol (XLS table in HIT, [7]).

3.11.3 Zone addressing in LTE Mode (in conjunction with Synco)

In cases where RDF KNX room thermostats are used in LTE Mode (e.g. in conjunction with Synco), zone addresses need to be allocated. The following zone address must be defined together with the Synco devices at the planning stage depending on the application.

Short description	Factory setting	Parameter
Geographical zone (apartment)	--- (out of service)	P82
Geographical zone (room)	1	P83
Heat distr zone heating coil	1	P84
Refr distr zone cooling coil	1	P85

Note: "Subzone" of "Geographical zone" is fix 1 (not adjustable).

The device will send and receive LTE communication signals only if the zone address is valid (not OSV = out of service).

The zones to be defined are as follows:

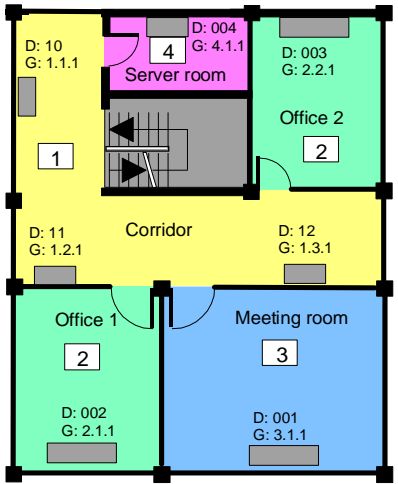
<p>Geographical zone (space zone) (Apartment . Room . Subzone) Apartment = ---, 1...126 Room = ---, 1...63 Subzone = fix 1</p>	<p>Zone in which an RDF KNX thermostat is physically located. Other room-specific devices may also be located in this zone.</p> <p>Information exchanged in this zone is related specifically to the device like operating mode, setpoints, room temperature, etc.</p> <p>The designations "Apartment", "Room" and "Subzone" do not need to be taken literally. For example, Apartment can be used to refer to a group of rooms, floor or section of a building. "Room", however, really does refer to a room.</p> <p>Subzone is not used for HVAC devices. It is more relevant to other disciplines, such as lighting. Subzone is fix at "1" and not visible.</p> <p>The time switch information is expected from the same zone where the thermostat is located (Residential).</p> <p>If no time switch information is received from the same zone, the thermostat will use the information received from the same apartment but with room "1" A.1.1 (Office).</p>
<p>Example: Commercial building</p> <p>In a commercial building, the time switch information is sent by the RMB795 central control unit. The zones are divided in so called "Room groups" (e.g. 1...4), where each "Room group" can have an individual schedule. A room thermostat in the same "Room group" needs to have the same Apartment Address.</p> <p>Legend: D = device address (P81) G = geographical zone (P82, P83) (Apartment.Room.Subzone)</p>	 <p>The diagram shows a floor plan with four room groups: <ul style="list-style-type: none"> Group 1 (Yellow): Includes a Corridor (D: 11, G: 1.2.1) and a Server room (D: 10, G: 1.1.1). Group 2 (Green): Includes Office 1 (D: 002, G: 2.1.1) and Office 2 (D: 003, G: 2.2.1). Group 3 (Blue): Includes a Meeting room (D: 001, G: 3.1.1). Group 4 (Purple): Includes a Server room (D: 004, G: 4.1.1). </p>
<p>Heat distribution zone heating coil Zone = ---, 1...31</p>	<p>Information related specifically to the hot water system in heating coils is exchanged within this zone. The zone also includes a Synco device to process the information (e.g. RMH7xx or RMU7xx with changeover).</p>
<p>Refrigeration distribution zone cooling coil Zone = ---, 1...31</p>	<p>Information related specifically to the chilled water system is exchanged within this zone (e.g. cooling demand). This zone also includes a Synco device to process the information (e.g. RMU7xx).</p>
<p>Outside temperature zone Zone = fixed to 31 RDF301...: SW < V3.7: fixed to 1</p>	<p>Outside temperature received in outside temperature zone 31 will be / can be displayed on the room thermostat when commissioned accordingly (parameter P07 = 2).</p>

3.11.4 Example of heating and cooling demand zone

The building is equipped with Synco controls on the generation side and RDF / RDG thermostats on the room side.

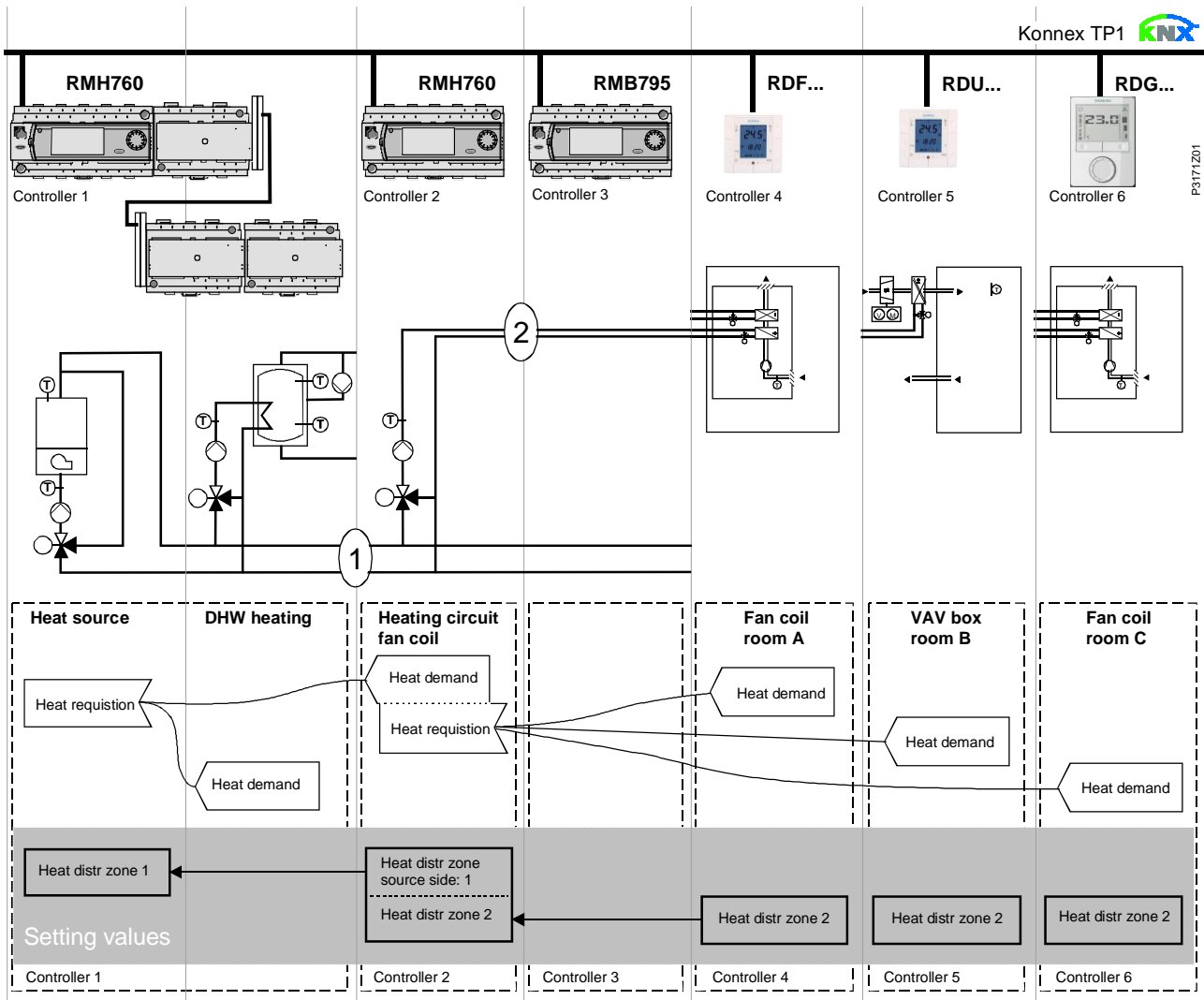

Explanation relating to the illustration

In the case of a typical application, the individual RDF / RDG room thermostats send their heat demand directly to the primary controller (in the above example to the RMH760).

(1) and (2) designate the numbers of the distribution zone.

- Note:
- This type of application can analogously be applied to refrigeration distribution zones.
 - If no 2-pipe fan coil is used, heat and refrigeration demand signals are sent simultaneously to the primary plant.

3.11.5 Send heartbeat and receive timeout

In a KNX network, S-Mode and LTE Mode communication objects can be exchanged between individual devices. The *Receive timeout* defines the period of time within which all the communication objects requested from a device must have been received at least once. If a communication object is not received within this period, a predefined value is used.

Similarly, the *Send heartbeat* defines the period of time within which all the communication objects requested must be transmitted at least once.

LTE Mode / S-Mode

Fixed times are specified as follows:

- Receive timeout: 31 minutes
- Send heartbeat: 15 minutes

Reducing the bus load

Individual zones can also be disabled (out of service) via control parameter if they are not being used. In disabled zones, the LTE signal will no longer be periodically sent, and will therefore reduce bus load.

3.11.6 Startup

Startup response

The application is restarted after every reset, so that all the connected motorized valve actuators are synchronized (see section 3.7).

Startup delay

After a reset, it takes up to 5 minutes for all the connected room thermostats to restart. This is designed to avoid overloading the mains power supply when restarting. At the same time, it reduces the load on the KNX network, as not all thermostats transmit data at the same time. The delay ($T_{\text{WaitDevice}}$) is determined by the thermostat's device address. After the delay, the device starts to send.



Heating output primary
Heating output
secondary
Cooling output primary

3.11.7 Heating and cooling demand

In conjunction with Synco, the heating and/or cooling demand from each room is transmitted to the BACS to provide the required heating or cooling energy.

An example for LTE Mode is described in section 3.11.4.

In S-Mode, the current state signals of the control outputs are available.

3.11.8 Fault function on KNX

If a fault occurs (e.g. digital fault input, dew point, communication configuration, etc.) then a fault will be sent on the bus.

An RDF thermostat listens on the bus and sends its fault when the fault has the highest alarm priority. This ensures that the management station does not miss any alarms.

If alarms occur at the same time, the alarm with the highest priority will be first displayed and sent on the bus.



Fault transmission is different in LTE Mode and S-Mode:

S-Mode	LTE Mode
Fault state	Alarm info (error code + internal information)
Fault information (internal information)	Alarm text (default text can be edited with ACS tool)

The table below shows the error code and default alarm texts.

Prio	Fault	Thermostat	Fault information on bus		
		Display	Error code	Default fault text	Text adjustable *)
-	No fault	---	0	No fault	✓
1	Bus power supply**)	🔔 BUS, 🔔 BUSF	5000	No bus power supply	---
2	Device address error	🔔 Addr	6001	>1 id device address	---
3	Condensation	🔔 💧	4930	Condensation in the room	✓
4	External fault input X1	🔔 AL1	9001	Fault input 1	✓
5	External fault input X2	🔔 AL2	9002	Fault input 2	✓
6	Clean filter reminder	🔔 FIL	3911	Dirty filter	✓

*) Default alarm texts are stored in the thermostat's non-volatile memory and can be adjusted using the ACS commissioning tool.

***) This error will not be sent on bus (because there is no bus, not enough bus power supply, bus is overloaded or bus signal is distorted).

Priority of alarms

- Priority order is #1...6
- External faults #4...5: If faults are active, the display will show AL1, AL2, alternating. On the bus, only the fault with the highest priority will be sent.



Fault transmission

A supervisor alarm system may command the thermostat to stop sending faults to the bus via the communication object "Fault transmission" (disable / enable). This has no impact on the local display of faults.

After a timeout of 48 hours, the sending of faults will automatically be enabled again.

3.11.9 KNX switching groups (RDF301.50, RDF301.50H only)



Light and blinds as well as scenes are operated via switching groups.

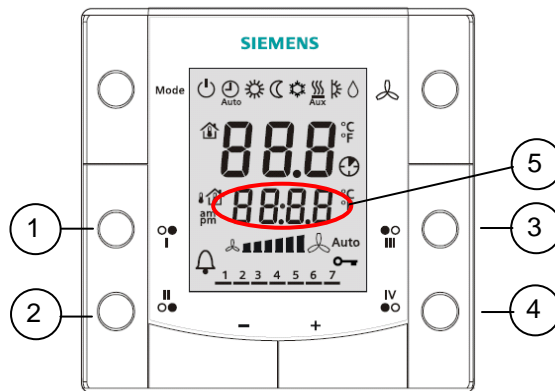

The communication objects of the buttons need to be bound to a corresponding KNX actuator module.



RDF301.50

- 1, 2 Buttons of switching group left (1).
- 3, 4 Buttons of switching group right (2).
- 5 Display for indication while pressing buttons.

RDF301.50H

- 1, 2  Button label: Make Up Room (MUR), ON/OFF.
- 3, 4  Button label: Do Not Disturb (DND), ON/OFF.
- 5 Display for indication while pressing buttons.

RDF301.50... has 2 switching groups with a pair of button each, which must be configured via ETS.

Commissioning of switching groups (ETS)

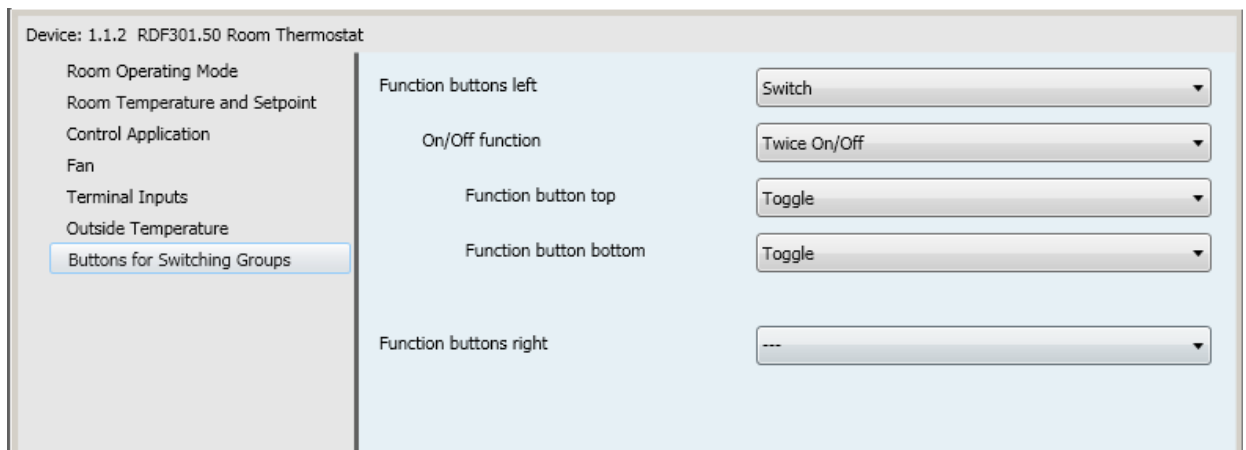

Parameters per switching group

#	Parameter		Parameter value
	Function left / right buttons	0	Inactive (factory setting)
		1	Switch
		2	Dim
		3	Shutter
		4	Scene

Parameters per single button

#	Function	Parameter		Parameter value
1	Switch	"ON/OFF" functions	0	Top: ON; bottom: OFF
			1	2 "ON/OFF" functions
				Function top button:
			0	Toggle (ON/OFF)
			1	ON
			2	OFF
			Function bottom button:	
			0	Toggle (ON/OFF)
			1	ON
			2	OFF

#	Function	Parameter		Parameter value
4	Scene	Scene number top button		1...63
		Scene number bottom button		1...63

Operating switching groups

The following functions are available:

- **Switching:** Toggle ON/OFF with 1 button or ON/OFF with 2 buttons (1 + 2 or 3 + 4). "ON" or "OFF" is displayed.
RDF301.50H: toggle ON/OFF function must be configured for MUR and DND hotel functions.
- **Dim lights** with 2 buttons (1 + 2 or 3 + 4):
ON/OFF with a short pulse (<0.5 s); "ON" or "OFF" is displayed.
Brighter / darker with a long pulse (>1 s); "dl" is displayed.
- **Operate blinds** with 2 buttons (1 + 2 or 3 + 4):
A long pulse (>1 s) starts the up/down motor; "UP" or "DOWN" is displayed.
A short pulse (<0.5 s) stops the motor or slightly adjusts the position of blinds; "ON" or "OFF" is displayed.
- **Scene** (button 1, 2, 3 or 4):
A scene can be used to recall certain states of all actuators involved, as well as to save new states as needed. E.g. differently dimmed lights and blind positions considered adequate for certain events / times.
A short pulse (<0.5 s) starts the scene. "CALL" is displayed, the scene is read from the bus.
A long pulse (>3 s) saves the actual position of all actuators involved as adjusted previously; "SAVE" is displayed, the new scene is sent on the bus.

Note: If commissioned as **inactive**, then pressing the buttons has no effect.

3.12 Communication objects (S-Mode)

3.12.1 Overview

Page	Object # and name	Thermostat	Object # and name	Page
13	1 System time	→		
13	3 Time of day	→		
13	44 Outside temperature	→	→ 21 Room temperature	13
			→ 16 Room operating mode: State ¹⁾	14
15	12 Room operating mode: Time switch ¹⁾	→	→ 24 Room temperature: Current setpoint	26
15	7 Room operating mode: Preselection ¹⁾	↔		
14, 17, 50	20 Room operating mode: Window state	→	→ 33 Fan operation (0 = Auto / 1 = Manual)	47
14, 17, 49	45 Room operating mode: Presence detector ³⁾	→	→ 35 Fan output	47
26	22 Room temperature: Comfort basic setpoint	→	→ 36 Fan stage 1	47
26	23 Room temperature: Comfort setpoint	↔	→ 37 Fan stage 2	47
24	46 Room temperature: Economy heating setpoint ³⁾	→	→ 38 Fan stage 3	47
24	47 Room temperature: Economy cooling setpoint ³⁾	→		
35	31 Application mode	→	→ 25 Heating output primary ²⁾	57
47	32 Enable fan command value	→	→ 26 Heating output secondary ²⁾	57
47	34 Fan command value	→	→ 27 Cooling output primary ²⁾	57
38, 51	29 Enable electric heater	→	→ 39/40 X1 (temperature / digital)	51
38, 51	29 Enable electric heater	→	→ 41/42 X2 (temperature / digital)	51
31, 50	30 Heating/cooling changeover	→	→ 5 Fault state	33, 58
58	6 Fault transmission	→	→ 4 Fault information	33, 49, 51, 58, 59
			→ 45.. Buttons left: ON/OFF	59
			↔ 45.. Button top left: ON/OFF	59
			↔ 46.. Button bottom left: ON/OFF	59
			→ 47 Buttons left: Dim up/down	59
			→ 48 Buttons left: Blind step/stop	59
			→ 49 Buttons left: Blind up/down	59
			→ 50 Buttons left: Scene	59
			→ 51.. Buttons right: ON/OFF	59
			↔ 51.. Button top right: ON/OFF	59
			↔ 53.. Button bottom right: ON/OFF	59
			→ 53 Buttons right: Dim up/down	59
			→ 54 Buttons right: Blind step/stop	59
			→ 55 Buttons right: Blind up/down	59
			→ 56 Buttons right: Scene	59

→ Input communication object

↔ Output communication object

↔ Input & output communication object

1) 8-bit and 1-bit object available, selectable via parameter in ETS

2) Availability depending on selected application / function

3) Only on RDF600KN SW >= V1.8

3.12.2 Description of communication objects

Obj	Object name	Function	Type/ length	Flags
1	System time	Time and date	19.001 8 Byte	CWU
System time for display on the room thermostat. See parameter P07 (3 or 4)				
3	Time of day	Time and date	10.001 3 Byte	CWU
Another object for receiving the time of day for display on the room thermostat. See parameter P07 (3 or 4)				
4	Fault information	Alarm Info	219.001 6 Byte	CT
Common alarm output. If an alarm occurs, the alarm number is transmitted				
5	Fault state	Faulty / normal	1.005 1 bit	CT
Common alarm output. If an alarm occurs, the alarm flag is set				
6	Fault transmission	Enable / disable	1.003 1 bit	CWU
A supervisor alarm system can disable the broadcasting of alarms by the devices. This has no impact on the local display of alarms. After a timeout of 48 hours, the sending of faults will automatically be enabled again.				
7	Room operating mode: Preselection	Auto Comfort PreComf. Economy Protection	20.102 1 Byte	CWTU
Controls the room operating mode selection of the thermostat via bus. The command can also be submitted as four 1-bit communication objects (8...11). The last interaction wins – either from local operating mode button or via bus. Note: The thermostat will transform Pre-Comfort either into Economy or Comfort (selectable via P88).				
8	Operating mode: Preselection Auto Comf Eco Prot	Trigger	1.017 1 bit	CW
9				
10				
11				
Switch room operating mode to either Auto, Comfort, Economy or Protection. The last interaction wins – either from the local operating mode button or via bus.				
12	Room operating mode: Time switch	Comfort Economy PreComf. Protection	20.102 1 Byte	CWU
This information is provided by a central time switch or a supervisor and defines the actual HVAC operating mode. The command can also be submitted via three 1-bit communication objects (13...15). Protection has the highest priority and cannot be overridden. Note: The thermostat will transform Pre-Comfort either into Economy or Comfort (selectable P88).				
13	Time switch Comfort Economy Protection	Trigger	1.017 1 bit	CW
14				
15				
Switch the HVAC mode to either Comfort, Economy or Protection mode.				

Obj	Object name	Function	Type/ length	Flags
16	Room operating mode: State	Comfort Economy Protection	20.102 1 Byte	CRT
Effective room operating mode used by the thermostat (considering time switch, user selection, window contact, etc.) This state information is available via one 8-bit enumeration or three 1-bit communication objects (17...19). Note: The thermostat does not support Pre-Comfort.				
17	Room operating mode: State State Comfort State Economy State Protection	ON	1.002 1 bit	CT
18		OFF		
19				
Corresponding communication object sends "True"				
21	Room temperature	Temp. value	9.001 2 Bytes	CRT
The value of the room temperature measured via built-in or external sensor is available via this communication object.				
22	Room temperature: Comfort basic setpoint	Temp. value	9.001 2 Bytes	CWU
If function "Temporary setpoint" is enabled via parameter P69, then after an operating mode change, the setpoint adjustments made by the user and via communication object 23 will be dismissed and the thermostat will be reset to the Comfort basic setpoint. Note: Setpoints that have been changed via the local HMI may be overwritten during a system startup from a central master controller, e.g.RMB795. <i>The Comfort basic setpoint is stored in EEPROM (see section 3.3.2). → The service life of the EEPROM depends on the number of write cycles. Never write this communication object cyclically!</i>				
23	Room temperature: Comfort setpoint	Temp. value	9.001 2 Bytes	CWTU
Communication object used to shift the setpoint used by the thermostat (see section 3.3.2). Same priority as local setpoint shift on the thermostat. The last intervention wins. Note: The Comfort basic setpoint (object 22) will not be changed.				
24	Current setpoint	Temp. value	9.001 2 Bytes	CRT
Current setpoint, including shift, compensation, etc., used by the thermostat for temperature control				
25	Heating output primary	0...100 %	5.001 8 bit	CRT
Indicates the position of the heating actuator of first stage. E.g. 2-pipe with electric heater application: Output of heating coil.				
26	Heating output secondary	0...100%	5.001 8 bit	CRT
Indicates the position of the heating actuator of the second stage. E.g. 2-pipe with electric heater application: Output of the electric heater.				
27	Cooling output primary	0...100%	5.001 8 bit	CRT
Indicates the position of the cooling actuator of the first stage. E.g. 2-pipe with electric heater application: Output of the cooling coil				
29	Enable electric heating	Enable / disable	1.003 1 bit	CWU
An electric heater can be disabled with this communication object (e.g. to meet tariff regulations). The same function is also available via local multifunctional input X1/X2 (parameter P38, P40). <i>Only one input source must be used, either local input X1/X2 or KNX bus.</i>				

Obj	Object name	Function	Type/ length	Flags
30	Heating / cooling changeover	Heat / Cool	1.100 1 bit	CWU
Changeover information transmitted via bus. Default: Current mode before power down. The same function is also available via local multifunctional input X1/X2 (parameter P38, P40). <i>Only one input source must be used, either local input X1/X2 or KNX bus..</i>				
31	Application mode	HVAC control mode	20.105 8 bit	CWU
0	Auto (default)	Heating and/or cooling		
1	Heat	Heating only		
2	Morning warmup*	Heating only		
3	Cool	Cooling only		
5	Precool*	Cooling only		
6	OFF	Neither heating nor cooling		
8	Emergency heat*	Heating only		
9	Fan only	Fan runs at high speed		
* Function handled like Heat (1) or Cool (3)				
32	Enable fan command value	Enable Disable	1.003 1 bit	CWU
Set fan mode to Auto (disable) or Manual (enable) by a KNX control unit. If Manual, the value received on <i>Fan command value (34)</i> will be used to command the fan speed. Default: Enable The last interaction wins – either from the local fan mode button or via bus.				
33	Fan operation	Auto Manual	1.001 1 bit	CRT
Indicates the status of the fan mode: Auto (0) or Manual (1).				
34	Fan command value	0...100%	5.001 8 bit	CWU
The fan can be set to a specified speed by a KNX control unit when manual fan operation is enabled.				
	Speed	Fan command value (physical KNX value)		
	1	1...33% (1...85)		
	2	34...67% (86...170)		
	3	68...100% (171...255)		
Fan speed "0" is not supported by the thermostat and the fan speed will remain unchanged.				
35	Fan output	0...100%	5.001 8 bit	CRT
Indicates the current fan speed as a value 0...100%				
	Speed	Fan output (physical KNX value)		
	OFF	0% (0)		
	1	33% (84)		
	2	66% (186)		
	3	100% (255)		
36	Fan speed 1	ON	1.001	CRT
37	Fan speed 2	OFF	1 bit	
38	Fan speed 3			
Indicate the state of the relay outputs				
39	X1: Temperature	Temp. value	9.001	CRT
40	X2: Temperature		2 Byte	
Indicate the values of the temperature sensors connected to the local inputs X1 / X2				
41	X1: Digital	ON	1.001	CRT
42	X2: Digital	OFF	1 bit	
Indicate the status of the digital inputs (adjusted by parameters P39/P41) including considering of operating action				
44	Outside temperature	Temp. value	9.001 2 Byte	CWU
The outside temperature measured by a KNX sensor can be displayed on the thermostat, if parameter P07 "Additional user information" is set = 2 (outside temperature).				

Obj	Object name	Function	Type/ length	Flags
45	Buttons left ON/OFF	ON OFF	1.001 1 bit	CT
51	Buttons right ON/OFF			
Switch control: Parameter ON/OFF functions = Top: ON; Bottom: OFF When pressing the button, the corresponding switching telegram is sent immediately.				
45	Button top left: ON/OFF	ON OFF	1.001 1 bit	CT CWTU 1)
46	Button bottom left: ON/OFF			
51	Button top right: ON/OFF			
52	Button bottom: Right ON/OFF			
Switch control: Parameter ON/OFF functions = 2 "ON/OFF" functions. When pressing the button, the corresponding switching telegram is sent immediately: ON, OFF or Toggle. 1) If "Toggle" is selected, the communication object becomes output and synchronization input				
45	Buttons left: ON/OFF	ON OFF	1.001 1 bit	CT
51	Buttons right: ON/OFF			
47	Buttons left: Dim up/down	Darker / Brighter	1.001 4 bit	CT
53	Buttons right: Dim up/down			
On a short operation of the button, a switching telegram is sent, e.g. press left top button: "On" is sent, press left bottom button: "OFF" is sent. When pressing the buttons longer, a dimming telegram is sent, e.g. press left top button: "Brighter" is sent, press left bottom button: "Darker" is sent. On releasing the button, a "Stop" telegram is sent.				
48	Buttons left: Blind step/stop	Step / Stop	1.001 1 bit	CT
54	Buttons right: Blind step/stop			
49	Buttons left: Blind up/down	Up / Down	1.001 1 bit	CT
55	Buttons right: Blind up/down			
On a short operation of the button, a telegram is sent to adjust the louvers or stop the blinds if moving up or down. On a long operation of the button, a telegram is sent to raise or lower the blinds (up or down)				
50	Buttons left: Scene	Scene control	18.001 8 bit	CT
56	Buttons right: Scene			
The "Scene (8-bit)" function is used to change the characteristics of a preset scene, i.e. brightness levels and switching states of a group within a scene, without using the ETS. For scene control, short and long (<1 s / > 3 s) pressing on the buttons are distinguished. On a short press, a telegram is sent to recall the corresponding scene. On a long press, a telegram is sent to save the corresponding scene. For each button a different scene number can be configured in ETS.				

Specific RDF600KN objects ¹⁾

20	Window state (RDF600KN)	Open Closed	1.019 1 bit	CWU
<p>The RDF600KN is set to Protection if value "1" (open) is received. It switches back to the previous mode when the value is "0" (closed).</p> <p>"Window state" is sent e.g by a KNX switch. It has the same effect as the local window contact X1, X2 (parameter P38, P40).</p> <p><i>Only one input source must be used, either local input X1/X2 or KNX bus.</i></p>				
45	Presence detector (RDF600KN)	Unoccupied Occupied	1.019 1 bit	CWU
<p>Standard presence: The thermostat is set to Comfort mode if value "1" (occupied) is received. It switches back to the Economy when the value is "0" (unoccupied).</p> <p>Hotel presence: The thermostat is set to previous mode (operating mode selected by either hotel guests via local HMI or the operating mode sent via bus) if value "1" (occupied) is received. It switches back to the Economy when the value is "0" (unoccupied).</p> <p>"Presence detector" is sent via KNX. It has the same effect as the local presence detector function on X1, X2 (parameter P38, P40).</p> <p><i>Only one input source must be used, either local input X1/X2 or KNX bus.</i></p>				
46	Room temperature: Economy heating setpoint (RDF600KN)	Temp. value	9.001 2 Bytes	CWU
<p>Communication object to adjust the Economy heating setpoint used by the thermostat (see section 3.3.2). It will direct change the value of the local parameter Economy setpoint P11.</p> <p>S-Mode object needs to be enabled by setting "Room temp. : Economy setpoints" to "as group object".</p> <p>The Economy setpoint is stored in EEPROM. The service life of the EEPROM depends on the number of write cycles. Never write this communication object cyclically.</p>				
47	Room temperature: Economy cooling setpoint (RDF600KN)	Temp. value	9.001 2 Bytes	CWU
<p>Communication object to adjust the Economy cooling setpoint used by the thermostat (see section 3.3.2). It will direct change the value of the local parameter Economy setpoint P12.</p> <p>S-Mode object needs to be enabled by setting "Room temp. : Economy setpoints" to "as group object".</p> <p>The Economy setpoint is stored in EEPROM. The service life of the EEPROM depends on the number of write cycles. Never write this communication object cyclically.</p>				

1) RDF600KN SW < V1.8 works like RDF301... with the operating mode switchover contact as window contact or presence detector.

Specific RDF301 object

20	Window state (on RDF301...)	Open Closed	1.019 1 bit	CWU
<p>The RDF301 is set to Economy mode if value "1" (open) is received. It switches back to the previous mode when the value is "0" (closed).</p> <p>"Window state" is sent e.g by a KNX switch or a KNX presence detector. It has the same effect as the local operating mode switchover contact X1, X2 (parameter P38, P40).</p> <p><i>Only one input source must be used, either local input X1/X2 or KNX bus.</i></p>				

3.13 Communication objects (LTE-Mode)

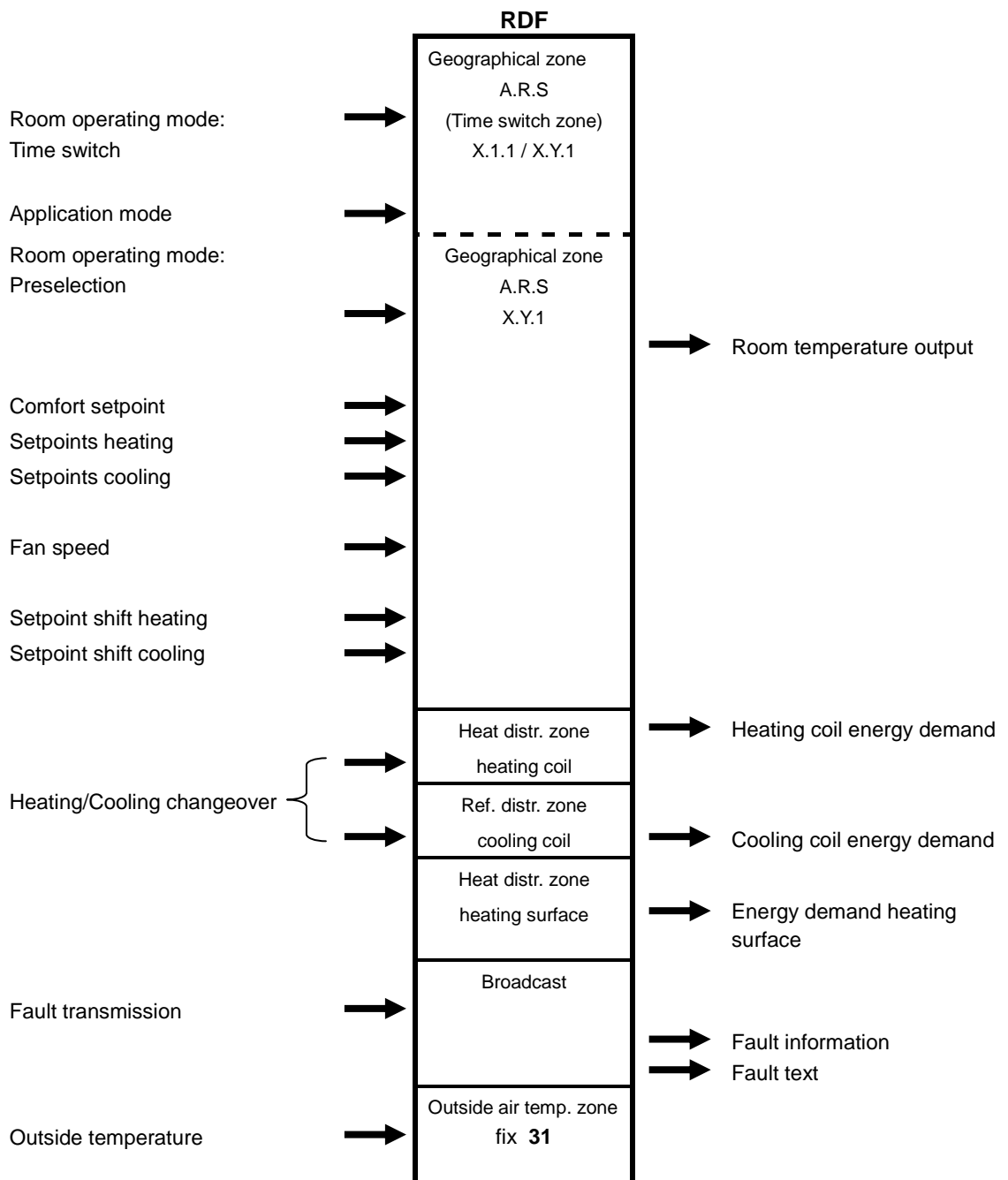

3.14 Control parameters

A number of control parameters can be readjusted to optimize control performance. This can be done on the thermostat via HMI or via commissioning / operating tool. These parameters can also be set during operation without opening the unit. In the event of a power failure, all control parameter settings are retained, see page 52.

The control parameters are assigned to 2 levels:

- "Service level", and
- "Expert level" including communications, diagnostics and test.

The "Service level" contains a small set of parameters to set up the thermostat for the HVAC system and to adjust the user interface. These parameters can be adjusted any time.

Change parameters at the "Expert level" carefully, as they impact the thermostat's control performance and functionality.

3.14.1 Parameter setting via local HMI

Enter only "Service" level

1. Press buttons + and – simultaneously for 4 seconds. Release and press **button +** again within 2 seconds until the display shows "P01". Continue with step 2.

Enter "Service" and "Expert" level.

1. Press buttons + and – simultaneously for 4 seconds. Release and press **button –** again within 2 seconds until the display shows "P01".

Adjust parameters

2. Repeatedly press the + or – button to select the required parameter.

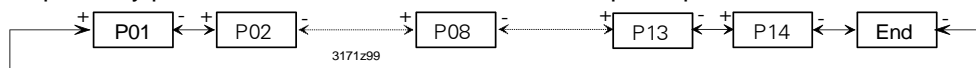

3. Press + and – simultaneously. The current value of the selected parameter begins to flash, allowing you to change the value by repeatedly pressing + or –.
4. The next parameter is displayed when you press + and – again simultaneously.
5. Repeat steps 2 to 4 to display and change additional parameters.
6. Press + or – until "End" is displayed, and then press + and – simultaneously to save the change and exit parameter entry mode.

Reset parameters

The factory setting for the control parameters can be reloaded via parameter P71, by changing the value to "ON", and confirming by pressing buttons + and – simultaneously. The display shows "8888" during reload.

3.14.2 Parameter setting / download via tool

Control parameters can be adjusted via bus either by parameter download during commissioning or during normal operation with a tool like ACS.



ACS

With the ACS tool, the parameters can be changed...

- during commissioning via parameter download (all parameters)
- during normal operation via Popcard (most of the parameters).

OZW772 Web server, RMZ792 bus operator unit

Most parameters can be changed during normal operation using the OZW772 web server or the RMZ792 bus operator unit.



ETS

ETS is an engineering tool and can be used for the full commissioning of the RDF KNX thermostats. Device address, application, control parameters and parameters for the switching groups can be defined and downloaded via ETS.

- Note:
- Setting RDF KNX parameters is only supported by ETS4 or higher / ACS version 5.11 or higher.
 - The RDF KNX thermostats (without ETS parameter download) require version ETS3f or higher.

Connecting a KNX tool

Connecting a KNX commissioning / operating tool to the RDF is described in section 4.2.

3.14.3 Parameters of the "Service level"

Parameter	Name	Factory setting	Range	RDF301..	RDF600KN	Dependencies
	Service level					
P01	Control sequence	2-pipe: 1 = Cooling only 4-pipe: 4 = Heating and Cooling	0 = Heating only 1 = Cooling only 2 = H/C changeover manual 3 = H/C changeover auto 4 = Heating and Cooling	✓	✓	
P02	Operation via room op selector	1	1 = Auto – Protection 2 = Auto - Comfort - Economy – Protection	✓	✓	P01
P04	Unit	0	0 = °C 1 = °F	✓	✓	
P05	Measured value correction	0 K	-3 ... 3 K	✓	✓	
P06	Standard display	0	0 = Room temperature 1 = Setpoint	✓	✓	
P07	Additional display information	0	0 = --- (No display) 1 = °C and °F 2 = Outside temperature (via bus) 3 = Time of day (12h) (via bus) 4 = Time of day (24h) (via bus)	✓	✓	
P08	Comfort basic setpoint	21 °C	5 ... 40 °C	✓	✓	
P09	Comfort setpoint minimum	5 °C	5 ... 40 °C	✓	✓	
P10	Comfort setpoint maximum	35 °C	5 ... 40 °C	✓	✓	
P11	Economy heating setpoint	15 °C	OFF, 5 ... WCoolEco; WCoolEco = 40 °C max	✓	✓	
P12	Economy cooling setpoint	30 °C	OFF, WHeatEco ... 40 °C; WHeatEco = 5C min	✓	✓	
P13	Electric heater when cooling	ON	ON: Enabled OFF: Disabled	✓	✓	Appl.
P14	Button lock	0	0 = Unlocked 1 = Auto lock 2 = Manual lock	✓	✓	
P15	Fan stage in dead zone (Comfort) (RDF600KN) ⁴⁾	0	0 = Disabled 1 = Low speed (Heat and Cool) 2 = Low speed (Cooling only)	x	✓	

⁴⁾ Not available on RDF600KN SW < V1.8

Note: Parameter display depends on selected application and function.

3.14.4 Parameters of the "Expert level with diagnostics and test"

Parameter	Name	Factory setting	Range	RDF301..	RDF600KN	Dependencies
	Expert level					
P30	Heat P-band Xp / switching diff	2 K	0.5 ... 6 K	✓	✓	
P31	Cool P-band Xp / switching diff	1 K	0.5 ... 6 K	✓	✓	
P33	Dead zone Comfort mode	2 K	0.5 ... 5 K	✓	✓	Appl.
P34	Setpoint differential	2 K	0.5 ... 5 K	✓	✓	Appl.
P35	Integral action time Tn RDF301... / RDF600KN	5 min 45 min	0...10 min 0...120 min	✓ x	x ✓	P46 P46
P36	H/C ch'over swi point cooling	16 °C	10...25 °C	✓	✓	P38, P40
P37	H/C ch'over swi point heating	28 °C	27...40 °C	✓	✓	P38, P40
P38	Input X1 RDF301..... (range 0..8) RDF600KN ⁵⁾ (range 0..10)	3 = Op mode contact, window contact	0 = --- (no function) 1 = Room temp ext. sensor / Return air temp (AI) 2 = H/C changeover (AI/DI) 3 = Operating mode contact, Window contact (DI) 4 = Dew point sensor (DI) 5 = Enable electric heater (DI) 6 = Fault input (DI) 7 = Monitor input (Digital) 8 = Monitor input (Temp) 10: Presence detector (DI)	✓	✓	
P39	Normal position input X1	0 (N.O.)	0 = Normally open / Open 1 = Normally closed / Close	✓	✓	P38
P40	Input X2 RDF301..... (range 0..8) RDF600KN ⁵⁾ (range 0..10)	1 = Ext. sensor	0 = --- (no function) 1 = Room temp ext. sensor / Return air temp (AI) 2 = H/C changeover (AI/DI) 3 = Operating mode contact, Window contact (DI) 4 = Dew point sensor (DI) 5 = Enable electric heater (DI) 6 = Fault input (DI) 7 = Monitor input (Digital) 8 = Monitor input (Temp) 10: Presence detector (DI)	✓	✓	
P41	Normal position input X2	0 (N.O.)	0 = Normally open / Open 1 = Normally closed / Close	✓	✓	P40
P44	Actuator running time Y11/Y21	150 s	20...300 sec	✓	✓	P46
P45	RDF600KN: Power of electric heater on Y21 (for adaptive temperature compensation)	0.0 kW	0.0...1.2 kW	x	✓	
P46	Output Y11/Y21	ON/OFF (1)	0 = 3-position 1 = ON/OFF	✓	✓	Appl.
P48	ON time minimum 2-pos output	1 min.	1...20 min	✓	✓	P46
P49	OFF time minimum 2-pos output	1 min.	1...20 min	✓	✓	
P50	Purge time	OFF	OFF: Not active 1...5 min: Active with selected duration	✓	✓	P38, P40

Parameter	Name	Factory setting	Range	RDF301..	RDF600KN	Dependencies
	Expert level					
P51	Flow temp limit floor heating	OFF	OFF, 10...50 °C	✓	✓	P38, P40
P52	Fan control	1	0 = Disabled 1 = Enabled 2 = Heating only 3 = Cooling only	✓	✓	
P53	Fan speeds	3-speed	1 = 1-speed 2 = 3-speed	✓	✓	P52
P54	Fan overrun time	60 sec	0...360 sec	✓	✓	P52, Appl.
P55	Fan speed switching point high	100%	80...100%	✓	✓	P52, P53, DIP
P56	Fan speed switching point med	65%	30..75%	✓	✓	P52, P53, DIP
P57	Fan speed switching point low	10%	1...15%	✓	✓	P52, P53, DIP
P58	Fan start kick	ON	ON: Enabled OFF: Disabled	✓	✓	P52
P59	On time minimum fan	2 min	1...6 min	✓	✓	P52
P60	Periodic fan kick Comfort RDF301... RDF600KN	0 OFF	0...89 min, OFF(90 ¹⁾)	✓ x	x ✓	P52
P61	Periodic fan kick Eco	OFF	0...359 min, OFF(360 ¹⁾)	✓	✓	P52
P62	Service filter	OFF (0 ¹⁾)	OFF, 100...9900 h	✓	✓	P52
P65	Protection heating setpoint	8 °C	OFF, 5...WCoolProt; WCoolProt = 40 °C max	✓	✓	
P66	Protection cooling setpoint	OFF	OFF, WHeatProt... 40; WHeatProt = 5°C min	✓	✓	
P67	Fan start delay (RDF600KN) ⁴⁾	0 s	0...360 s	x	✓	P52, P46
P68	Temporary Comfort mode	0 (= OFF)	0...360 min	✓	✓	P02
P69	Temporary Comfort setpoint	OFF	OFF = Disabled ON = Enabled	✓	✓	
P71	Restore factory setting	OFF	OFF = Disabled ON = Reload start "8888" is displayed for 3s during reload process	✓	✓	
P77	Presence detection	1 = Standard presence mode	1 = Standard presence mode 2 = Hotel presence mode	x	✓	





¹⁾ The numbers are displayed in ACS tool

⁴⁾ Not available on RDF600KN SW < V1.8

⁵⁾ On RDF600KN SW < V1.8, setting range 0...8

Parameter	Name	Factory setting	Range	RDF301..	RDF600KN	Dependen-cies
	Communications					
P81	Device address ¹⁾	255	1...255	✓	✓	
P82	Geographical zone (apartment) ²⁾	---	---, 1...126	✓	✓	
P83	Geographical zone (room) ²⁾	1	---, 1...63	✓	✓	
P84	Heat distr zone heating coil	---	---, 1...31	✓	✓	Appl., P01
P85	Refrig distr zone cooling coil	---	---, 1...31	✓	✓	Appl., P01
P88	Transformation Pre-Comfort	0	0 = Economy 1 = Comfort	✓	✓	

- ¹⁾ Physical address = Area.Line. DeviceAddress. Factory setting for Area = 0, Line = 2.
Can be changed by special management service e.g. from line coupler or via ACS commissioning tool.
- ²⁾ Type = geographical zone A.R.S. In RDF sub zone = fixed value 1.

Parameter	Name	Range	Dependen-cies
	Diagnostics & test		
d01	Application number	NONE = (No application) 2P = 2-pipe 2P3P = 2-pipe 3-position 2PEH = 2-pipe with electric heater 4P = 4-pipe	
d02	X1 state	"---" = function not selected 0 = Not activated (for DI) 1 = Activated (DI) 0...49 °C = Current temp. value (for AI) 00  = H/C Input shorted 100  = H/C Input open	
d03	X2 state	"---" = function not selected 0 = Not activated (for DI) 1 = Activated (DI) 0...49 °C = Current temp. value (for AI) 00  = H/C Input shorted 100  = H/C Input open	
d05	Test mode for checking the Y11/Y21 actuator's running direction ³⁾	"---" = no signal on outputs Y11 and Y21 OPE = output Y11 forced opening CLO = output Y21 forced closing	P46

- ³⁾ This parameter can only be quit when the setting is back at "---".
Press buttons + and – simultaneously to escape.

4. Handling

4.1 Mounting and installation

Mount the room thermostat on the conduit box. Do not mount on a wall in niches or bookshelves, behind curtains, above or near heat sources, or exposed to direct solar radiation. Mount about 1.5 m above the floor.

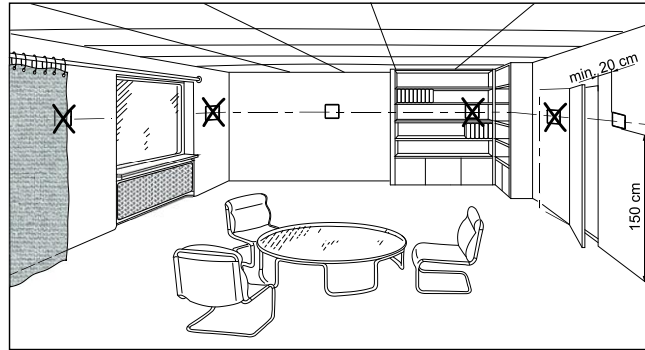

Mounting / dismounting



- Mount the room thermostat in a clean, dry indoor place without direct airflow from a heating / cooling device, and not exposed to dripping or splash water.
- In case of limited space in the conduit box, use mounting bracket ARG70.3 to increase the headroom by 10 mm.

Wiring

See Mounting Instructions enclosed with the thermostat.

M3171... [3], M3076.1 [3a]



- Comply with local regulations to wire, protection and earth the thermostat.

Warning!

No internal line protection for supply lines to external consumers (Q1, Q2, Q3, Yxx)

Risk of fire and injury due to short-circuits!

- Adapt the line diameters as per local regulations to the rated value of the installed overcurrent protection device.
- The AC 230 V mains supply line must have an external circuit breaker with a rated current of no more than 10 A.
- Properly size the cables to the thermostat, fan and valve actuators for AC 230 V mains voltage.
- Use only valve actuators rated for AC 230 V.
- Cables of SELV inputs X1-M/X2-M: Use cables with 230 V insulation, as the conduit box carries AC 230 V mains voltage.
- Inputs X1-M or X2-M: Several switches (e.g. summer / winter switch) may be connected in parallel. Consider overall maximum contact sensing current for switch rating.
- KNX communication cables (input CE+ / CE-): Use cables with 230 V insulation, as the conduit box carries AC 230 V mains voltage.
- Disconnect from supply before opening the cover.
- When a KNX bus power supply is connected on the line with communicating thermostats and Synco controller, the internal KNX power supply of the Synco controllers must be switched off.



4.2 Commissioning

Applications

The room thermostats are delivered with a fixed set of applications.

Select and activate the relevant application during commissioning using one of the following tools:

- Local DIP switch and HMI
- Synco ACS
- ETS

DIP switches

Set the DIP switches before snapping the front panel to the mounting plate, if you want to select an application via **DIP switches**.

All DIP switches need to be set to "OFF" (remote configuration), if you want to select an application via **commissioning tool**.

After power is applied, the thermostat resets and all LCD segments flash, indicating that the reset was correct. After the reset, which takes about 3 seconds, the thermostat is ready for commissioning by qualified HVAC staff.

If all DIP switches are OFF, the display reads "NONE" to indicate that application commissioning via a tool is required.

Note: Each time the application is changed, the thermostat reloads the factory setting for all control parameters, except for KNX device and zone addresses!

Connect tool

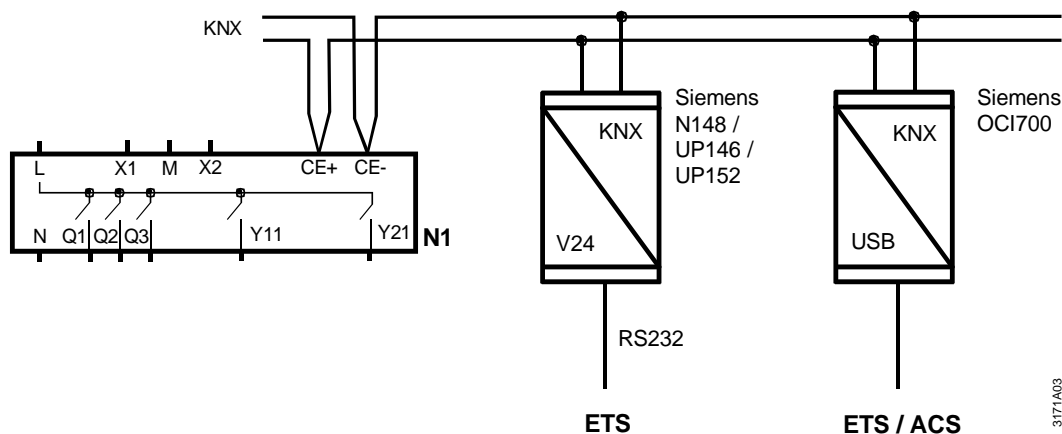

Connect the Synco ACS or ETS tools to the KNX bus cable at any point for commissioning:



ACS and ETS require an interface:

- RS232 KNX interface (e.g. Siemens N148 / UP146 / UP152)
- OCI700 USB-KNX interface

Note: An external KNX bus power supply is required if an RDF is connected directly to a tool (ACS or ETS) via KNX interface.

Control parameters	<p>The thermostat's control parameters can be set to ensure optimum performance of the entire system.</p> <p>The parameters can be adjusted using</p> <ul style="list-style-type: none"> – Local HMI – Synco ACS – ETS <p><i>Commissioning</i> of switching groups for RDF301.50... is only possible with ETS).</p> <p>The control parameters of the thermostat can be set to ensure optimum performance of the entire system (see section 3.14).</p>						
Control sequence	<ul style="list-style-type: none"> • The control sequence may need to be set via parameter P01 depending on the application. The factory setting is as follows: <table border="1" style="width: 100%; border-collapse: collapse;"> <thead> <tr> <th style="text-align: left;">Application</th> <th style="text-align: left;">Factory setting P01</th> </tr> </thead> <tbody> <tr> <td>2-pipe and chilled / heated ceiling</td> <td>1 = cooling only</td> </tr> <tr> <td>4-pipe, chilled ceiling and radiator</td> <td>4 = heating and cooling</td> </tr> </tbody> </table>	Application	Factory setting P01	2-pipe and chilled / heated ceiling	1 = cooling only	4-pipe, chilled ceiling and radiator	4 = heating and cooling
Application	Factory setting P01						
2-pipe and chilled / heated ceiling	1 = cooling only						
4-pipe, chilled ceiling and radiator	4 = heating and cooling						
Compressor-based applications 	<ul style="list-style-type: none"> • When the thermostat is used with a compressor, adjust the minimum output on-time (parameter P48) and OFF-time (parameter P49) for Y11/Y21 to avoid damaging the compressor or shortening its life due to frequent switching. 						
Calibrate sensor	<ul style="list-style-type: none"> • Recalibrate the temperature sensor if the room temperature displayed on the thermostat does not match the room temperature measured (after min. 1 hour of operation). To do this, change parameter P05. 						
Setpoint and range limitation	<ul style="list-style-type: none"> • We recommend to review the setpoints and setpoint ranges (parameters P08...P12) and change them as needed to achieve maximum comfort and save energy. 						
Programming mode	<p>The programming mode helps identify the thermostat in the KNX network during commissioning.</p> <p>Press buttons "operating mode"  and "+" simultaneously for 6 sec to activate programming mode, which is indicated on the display with "PrOG".</p> <p>Programming mode remains active until thermostat identification is complete.</p>						
Assign KNX device address	<p>Assign device address (P81) via HMI, ACS or ETS.</p> <p>With device address set to 255, the communication is deactivated (no exchange of process data).</p>						
Assign KNX group addresses	<p>Use ETS to assign the KNX group addresses of the thermostat's communication objects.</p>						
Switching groups RDF301.50... only	<p>RDF301.50 and RDF301.50H have 2 switching groups with a pair of buttons each, which must be configured via ETS. The switching groups only work in S-Mode.</p>						
KNX serial number	<p>Each device has a unique KNX serial number inside the front panel. An additional sticker with the same KNX serial number is enclosed in the packaging box. This sticker is intended for installers for documentation purposes.</p>						

4.3 Operation

See also Operating Instructions B3171 [2] enclosed with the thermostat.

Layout

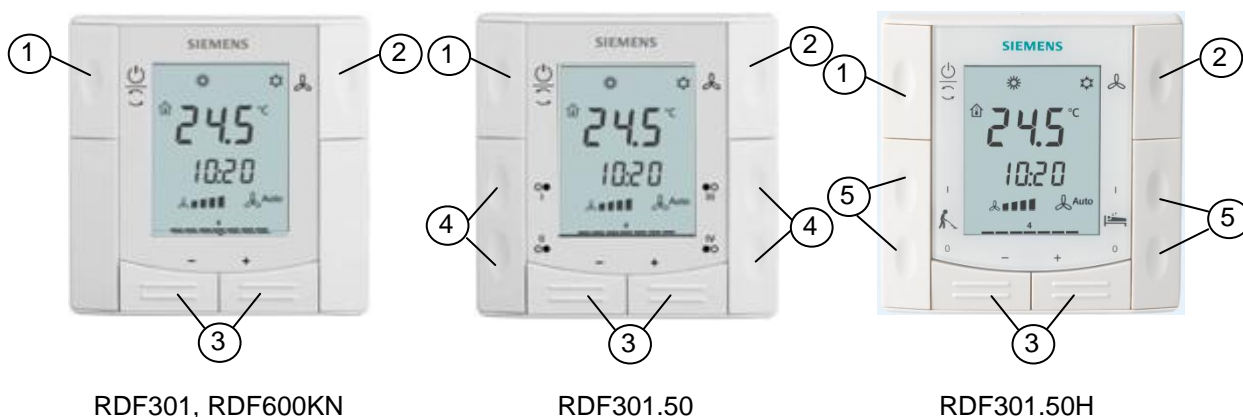

- 1 Operating mode selector
- 2 Button to change fan operation
- 3 Buttons to adjust setpoints and control parameters
- RDF301.50 4 Four buttons to control KNX actuators via KNX S-Mode (functions: switching, dimming, blind control, 8-bit scene)
- RDF301.50H 5 Four dedicated buttons for hotel functions (Make Up Room, Do Not Disturb) via KNX S-Mode (functions: switching)

Button operation

User action	Effect, description
Normal operation	Actual operating mode and state are indicated by symbols
Press any button (thermostat in normal operation)	Backlit LCD turns on and... (see below for further action) After the last operation and a timeout of 10 seconds, the LCD backlight turns off
Press left button (operating mode)	Change operating mode
Press left button (P01 = 2)	Toggle between heating and cooling
Press left button while "Operating mode switchover" via bus is activated	Activate "Extend Comfort mode" (for details, see page 19)
Press left button >5 / >3 seconds (RDF301... / RDF600KN)	Activate / deactivate button lock
Press right button	Change fan mode
Press + or -	Adjusts the Comfort room temperature setpoint . Thermostat changes to Comfort mode
Press + and - >3 seconds, release, then press + again >3 seconds	Go to parameter setting mode "Service level"
Press + and - >3 seconds, release, then press - again >3 seconds	Go to parameter setting mode "Expert level", diagnostics and test
Press operating mode button and "+" simultaneously for 6 seconds	Enter (KNX) programming mode

Display

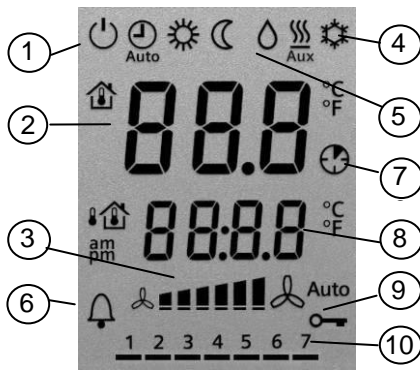

- | | |
|---|--|
| <p>1 Operating mode</p> <ul style="list-style-type: none"> Protection Comfort Economy Auto Timer according to schedule (via bus) <p>2 Displays room temperature, set-points and control parameters.</p> <ul style="list-style-type: none"> Symbol indicates current room temperature <p>3 Fan mode</p> <ul style="list-style-type: none"> Auto fan active Fan speed low, medium, high <p>4 Heating / cooling mode</p> <ul style="list-style-type: none"> Cooling Heating Electric heater active | <p>5 Condensation in room (dew point sensor active)</p> <p>6 Indicates fault or reminder</p> <p>7 Temporary Comfort mode extension active</p> <p>8 Additional user information, like outside temperature or time of day from KNX bus. Selectable via parameters</p> <p>9 Button lock active</p> <p>10 <u>1 2 3 4 5 6 7</u>
Weekday 1...7 from KNX bus (1 = Monday / 7 = Sunday)</p> |
|---|--|

4.4 Remote operation

The RDF KNX thermostats can be operated from a remote location using a OZW772 web server, a RMZ792 bus operating unit or the ACS tool.

4.5 Disposal



The devices are considered electronics devices for disposal in terms of European Directive 2012/19/EU and may not be disposed of as domestic waste.

- Dispose of the device via the channels provided for this purpose.
- Comply with all local and currently applicable laws and regulations.

5. Supported KNX tools

5.1 ETS



ETS

ETS is an engineering tool. It can be used for the full commissioning of the RDF KNX thermostats.

The following functions can be realized with ETS4:

- Define and download the physical address
- Define and download the application (plant type, control sequence)
- Set up and download the thermostat's control parameters
- Download the switching group parameters (RDF301.50)
- Set up and download group addresses.

This basic documentation does not describe how to operate ETS and commission a device. Refer to the KNX Manual for more details.



Note!

Setting RDF KNX parameters is only supported by ETS4 or higher. ETS4 can be updated online.

5.1.1 Parameter settings in ETS

For setting the parameters, open the project and select a device.
To start the parameter settings, select **Edit**, then **Edit parameters**.

Parameter	Setting
Plant type	2-pipe
Control Sequence	Cooling only
[P02] Operation via room op selector	Auto - Protection
[P04] Unit	Degrees Celsius
[P06] Standard display	Room temperature
[P07] Additional display information	----
[P14] Keypad	Unlocked
[P68] Temporary comfort mode [minutes]	0

- Note:
- The ETS version 3f or higher can be used to assign the communication objects to group addresses (S-Mode).
 - The ETS4 or higher can be used to download the application and parameters.

The **application** (plant type) and **Control Sequence** can be adjusted and downloaded.

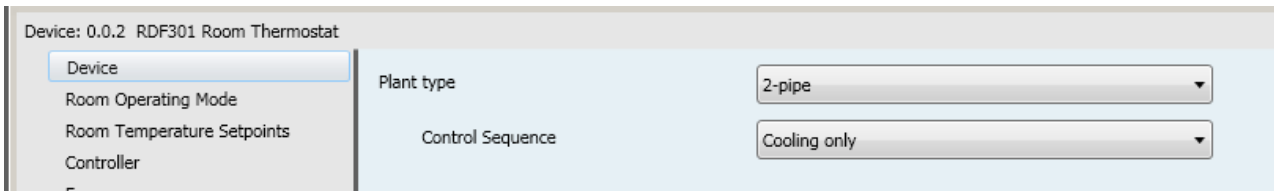

Device: 0.0.2 RDF301 Room Thermostat

Device	Plant type	2-pipe
Room Operating Mode	Control Sequence	Cooling only
Room Temperature Setpoints		
Controller		

The **control parameters**, ([Pxx] description) can also be adjusted and downloaded. Refer to section 3.13.

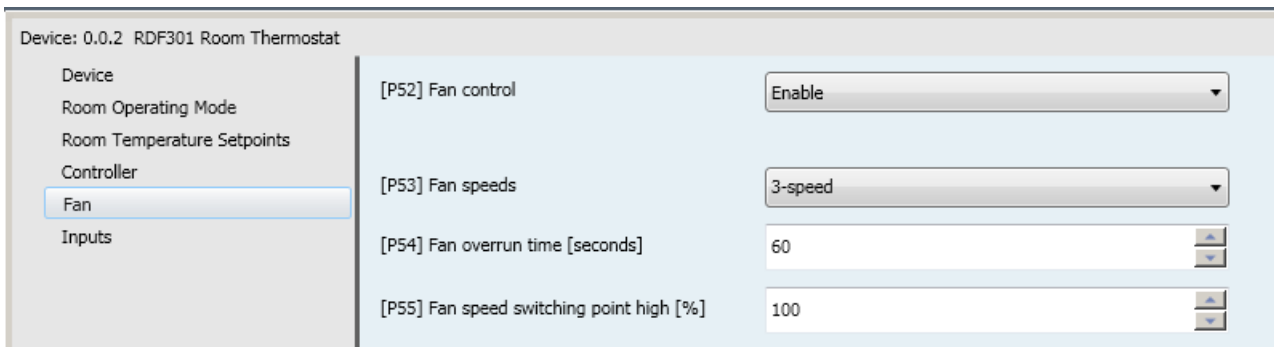

Device: 0.0.2 RDF301 Room Thermostat

Device	[P52] Fan control	Enable
Room Operating Mode	[P53] Fan speeds	3-speed
Room Temperature Setpoints	[P54] Fan overrun time [seconds]	60
Controller	[P55] Fan speed switching point high [%]	100
Fan		
Inputs		

5.2 ACS Service and Operating tool



ACS

With the ACS tool, the RDF KNX thermostats can be commissioned (physical address, application, parameters). They can be operated or monitored via bus during normal operation.

This Manual does not describe how the physical address is defined. Also, it only gives a brief overview of the main functionality of ACS.

For more information, refer to the ACS online help.



Note!

Setting RDF KNX parameters is only supported by ACS Version 5.11 or higher.

5.2.1 Parameter settings in ACS

In the **ACS** program, select **Plant**, then **Open** to open the plant.
To start the parameter settings, select **Applications**, then **Plant engineering...**:

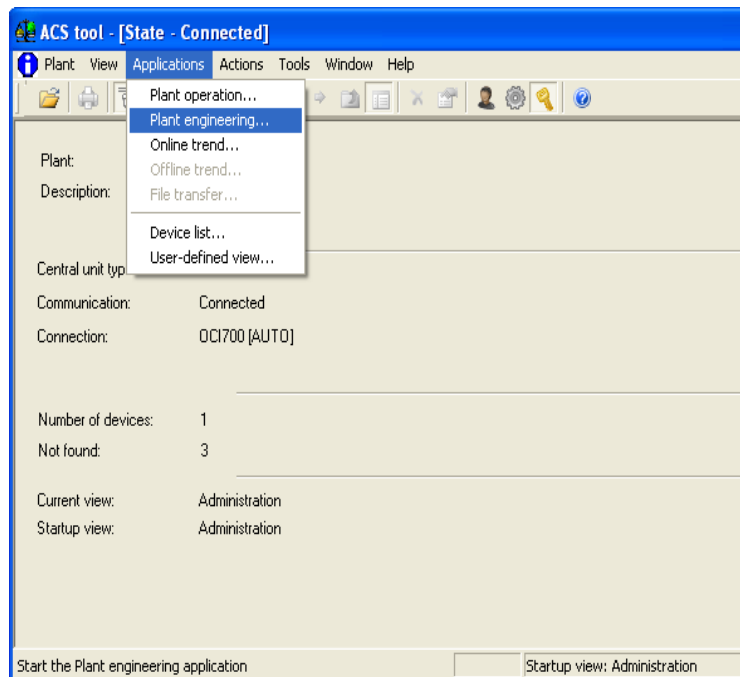

The **application** and **control parameters** can be adjusted and downloaded.
Column *Line no.* contains the parameter number as shown in the parameter table.
Refer to section 3.13, control parameters.

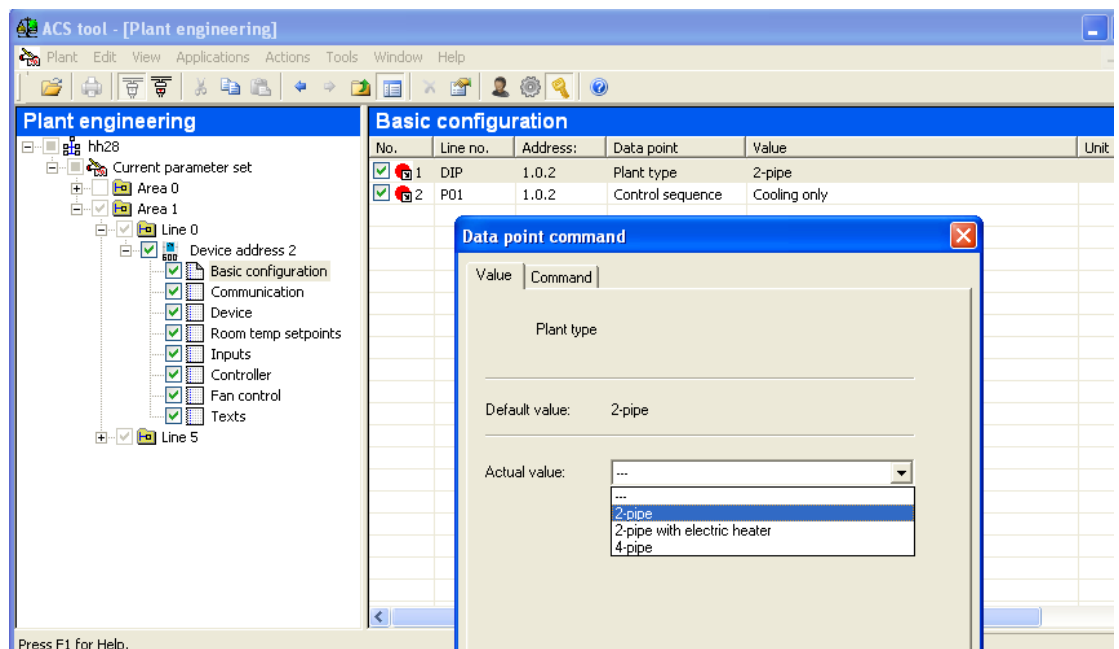

5.2.2 Operation and monitoring with ACS



ACS

In the ACS program, select **Plant**, then **Open** to open the plant.
To start monitoring and operation, select **Applications**, then **Plant operation**.

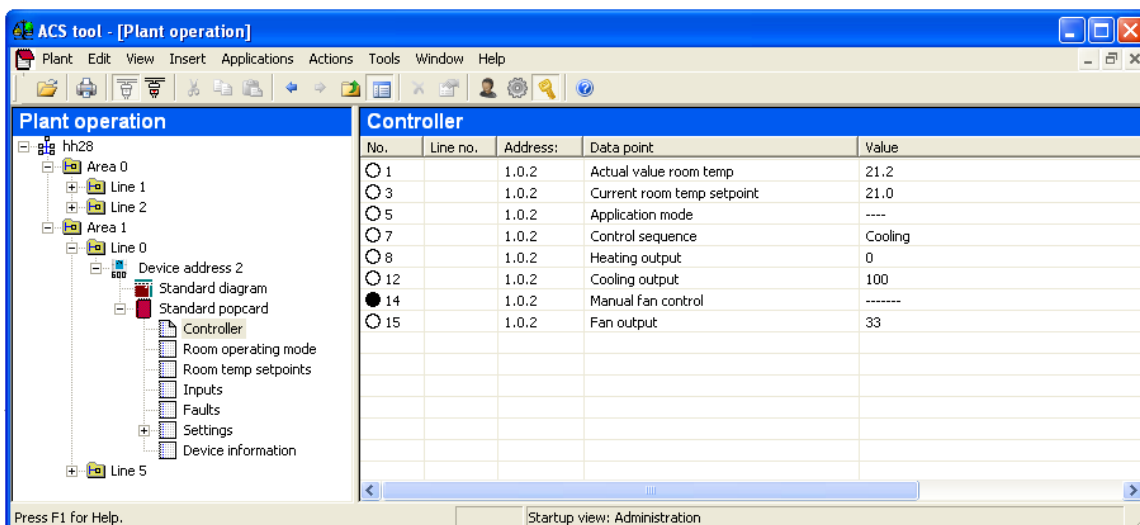

Parameter settings in ACS

ACS supports parameter settings even during normal operation.

To change a control parameter, select **Popcard**, then **Settings**.

- Note:
- Make sure you have logged on with sufficient access right
 - Only control parameter can be changed, no application!

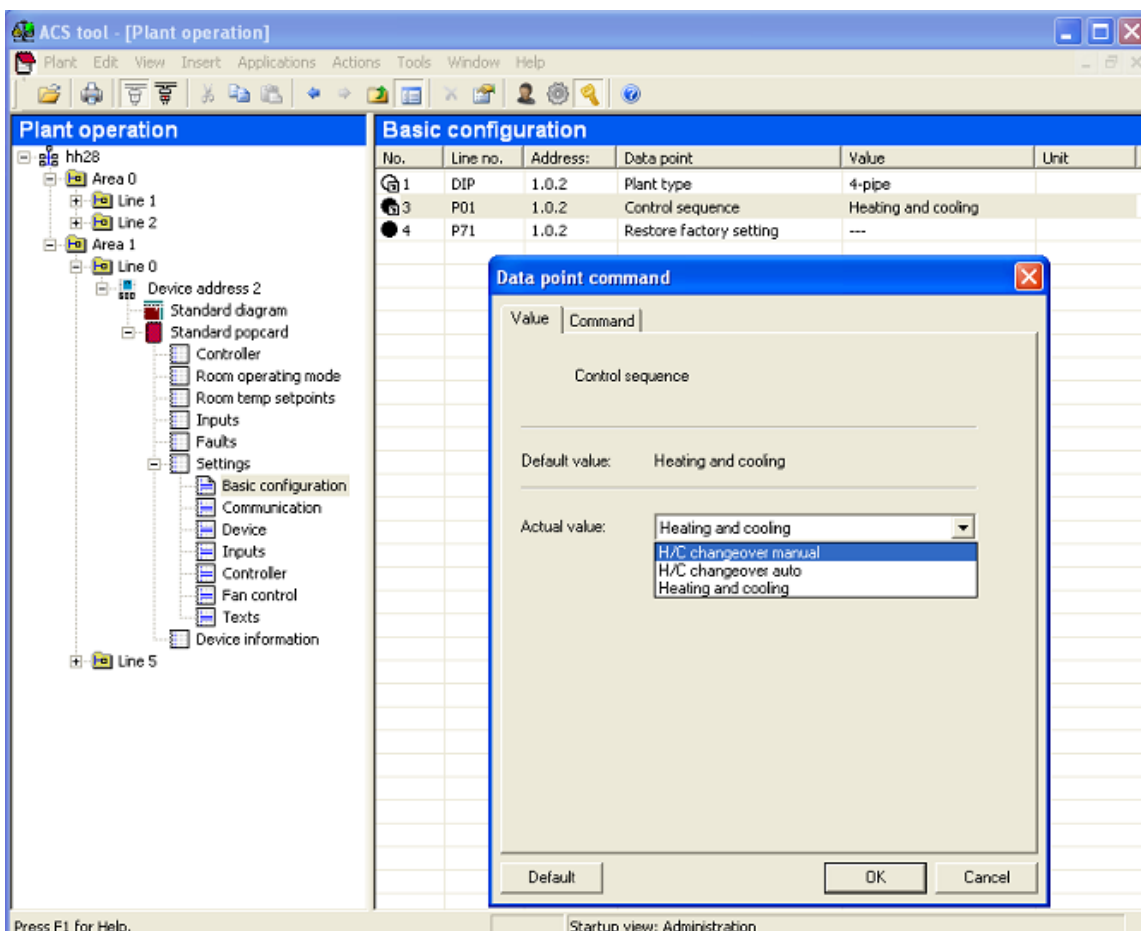

Plant diagram in ACS

ACS offers plant diagrams for easy monitoring and operation of the thermostat. To start this application, select **Applications**, then **Pant diagram**.

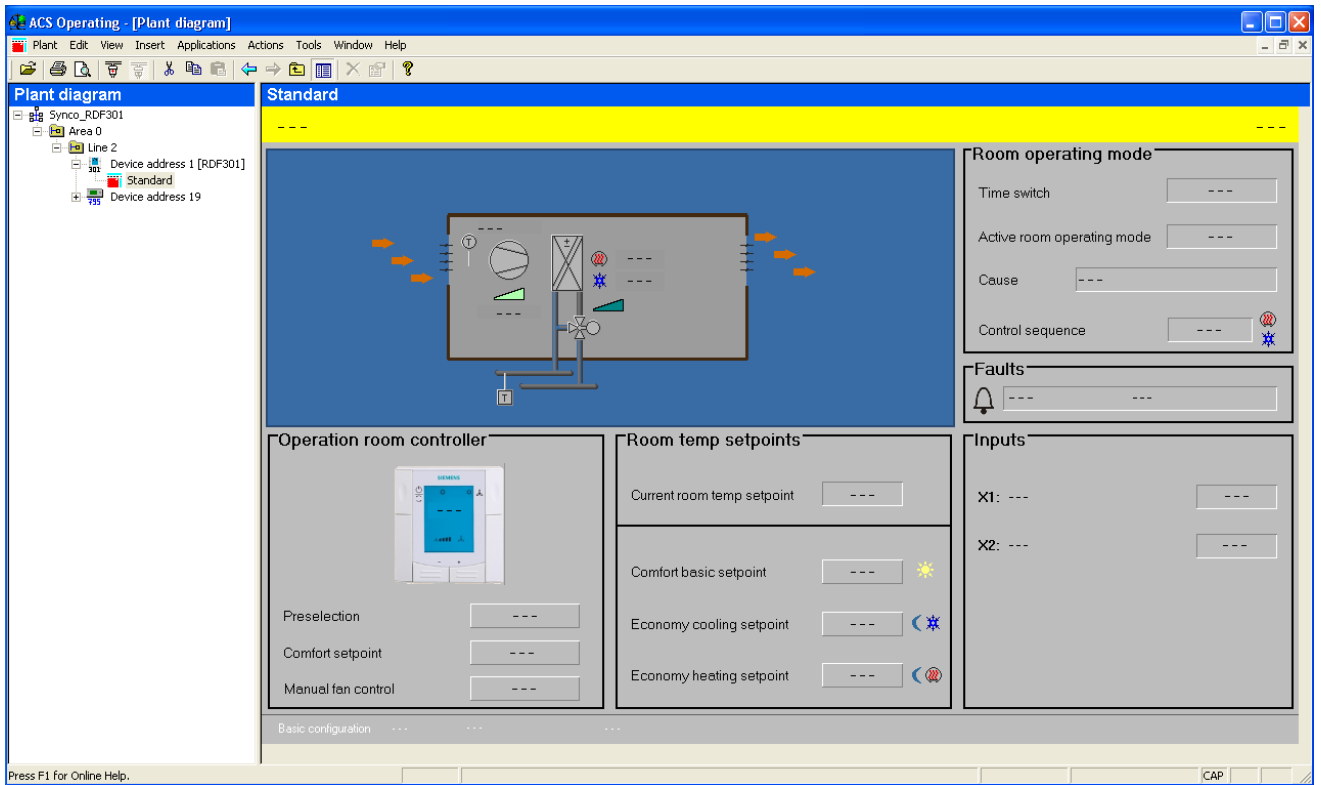

ACS provides standard plant diagrams for RDF KNX thermostats, which depend on the configuration as follows:

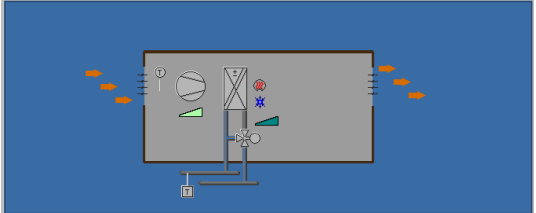
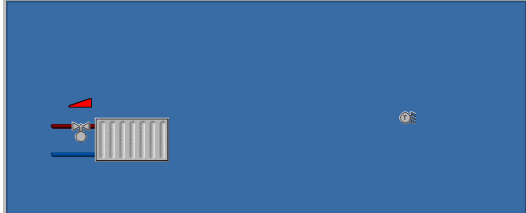
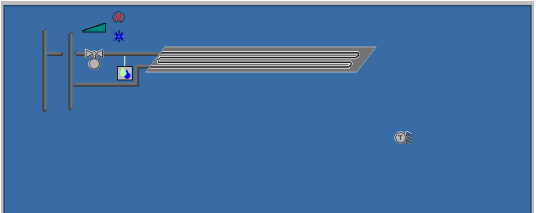
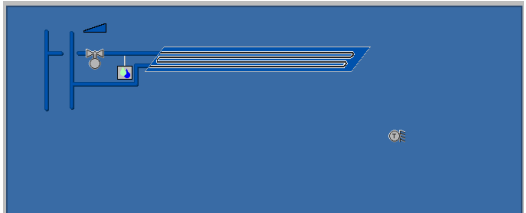
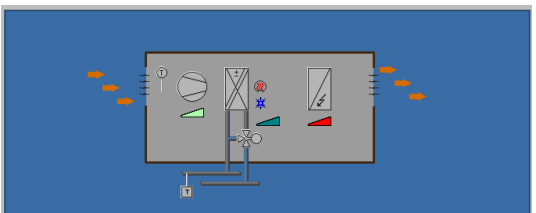
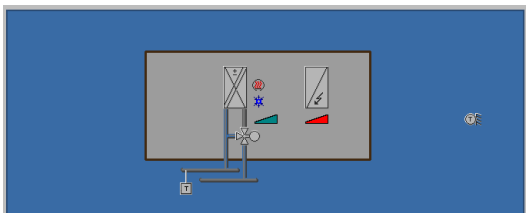
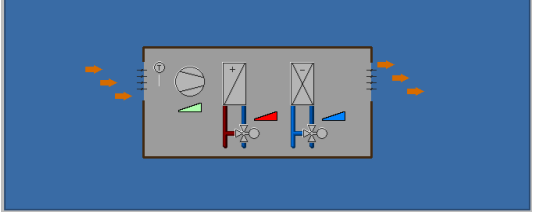
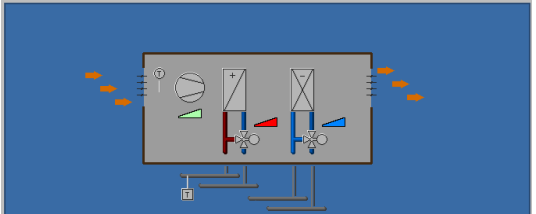
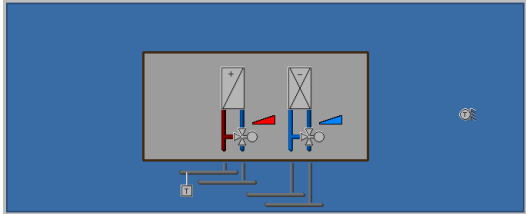
• Plant type	Application Configuration	Application Configuration
2-pipe	<p>2-pipe fan coil unit</p> <ul style="list-style-type: none"> – Control sequence: No impact (P01 = any) – Fan operation: Not disabled (P52 <> 0) 	<p>Radiator</p> <ul style="list-style-type: none"> – Control sequence: Heating only (P01 = 0) – Fan operation: Disabled (P52 = 0) 
	<p>Chilled / heated ceiling</p> <ul style="list-style-type: none"> – Control sequence: Changeover (P01 = 2,3) – Fan operation: Disabled (P52 = 0) 	<p>Chilled ceiling</p> <ul style="list-style-type: none"> – Control sequence: Cooling only (P01 = 1) – Fan operation: Disabled (P52 = 0) 
2-pipe and electric heater	<p>2-pipe fan coil unit with electric heater</p> <ul style="list-style-type: none"> – Control sequence: No impact (P01 = any) – Fan operation: Not disabled (P52 <> 0) 	<p>Single stage with electric heater</p> <ul style="list-style-type: none"> – Control sequence: No impact (P01 = any) – Fan operation: Disabled (P52 = 0) 
	4-pipe	<p>4-pipe fan coil unit</p> <ul style="list-style-type: none"> – Control sequence: Not auto c/o (P01 <> 3) – Fan operation: Not disabled (P52 <> 0) 
<p>Fan coil unit main / secondary</p> <ul style="list-style-type: none"> – Control sequence: Auto c/o (P01 = 3) – Fan operation: Not disabled (P52 <> 0) 		<p>Main / secondary</p> <ul style="list-style-type: none"> – Control sequence: Auto c/o (P01 = 3) – Fan operation: Disabled (P52 = 0) 

5.2.3 Operation and monitoring with OZW772

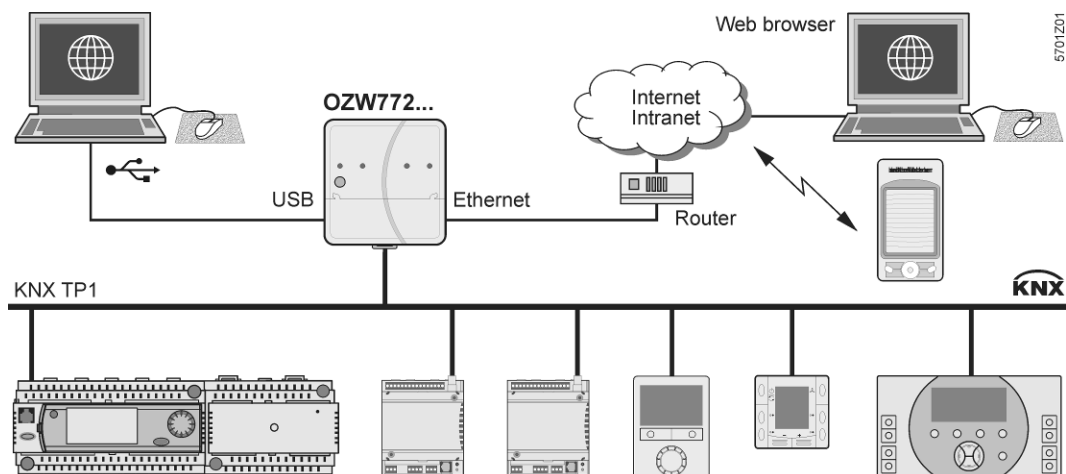

5701201



**HomeControl app
for plant control**

The OZW772 web server enables users to operate a Synco HVAC system from a remote location – via PC, or from a smart phone – using the HomeControl app. A start page shows the most important data points. A combination of menu / path navigation enables users to access all data points quickly and straightforwardly. The entire installation can be visualized in the form of plant diagrams. Alarm and state messages can be forwarded to different message receivers, such as e-mail, SMS, etc.

For details, see Commissioning Instructions CE1C5701.

5.2.4 Operation and monitoring with RMZ972



The RMZ972 is a communicating operator unit designed for operating Synco™ 700 and RDF KNX devices in a KNX network. The operator unit is suited both for fixed installation and mobile use (e.g. for use by the service engineer). Third-party devices cannot be operated with it.

For details, see Basic Documentation CE1P3113.

Note: The application cannot be displayed in the form of text, instead a number is used: (Parameter **Plant type** on menu **Basic setting**):

- 0 = no application
- 1 = 2-pipe
- 2 = 2-pipe and electric heater
- 4 = 4-pipe

6. Connection

6.1 Connection terminals

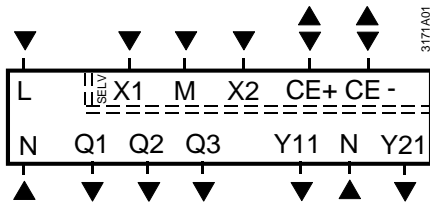

L, N	Operating voltage AC 230 V
Q1	Control output "Fan speed 1 AC 230 V"
Q2	Control output "Fan speed 2 AC 230 V"
Q3	Control output "Fan speed 3 AC 230 V"
Y11, Y21	Control output "Valve" AC 230 V (NO, for normally closed valves), output for compressor or output for electric heater
X1, X2	Multifunctional inputs for temperature sensor (e.g. QAH11.1) or potential-free switch Factory setting: – X1 = Operating mode switchover contact – X2 = External sensor (function can be selected via parameters P38 / P40).
M	Measuring neutral for sensor and switch
CE+	KNX data +
CE-	KNX data -

6.2 Connection diagrams

Application

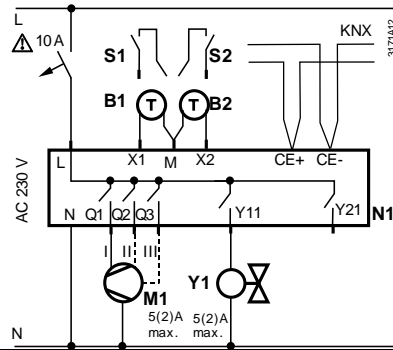

- N1 Room thermostat
RDF301... , RDF600KN
- M1 1- or 3-speed fan
- Y1 Valve actuator, 2- or 3-position
- Y1, Y2 Valve actuator, 2-position
- E1 Electric heater
- C1, C2 1-stage compressor
- S1, S2 Switch (keycard, window contact, presence detector, etc.)
- B1, B2 Temperature sensor (return air temperature, external room temperature, changeover sensor, etc.)
- CE+ KNX data +
- CE- KNX data -

2-pipe, 2-position

2-pipe, 3-position
– Y11 = Open
– Y21 = Close

2-pipe and electric heater

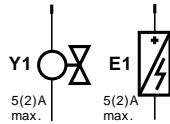
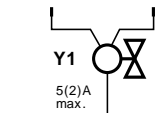

4-pipe
– Y1 = Heating
– Y2 = Cooling

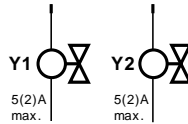

1-stage compressor
– C1 = Heating and / or
– C2 = Cooling

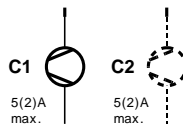

1-stage compressor and electric heater

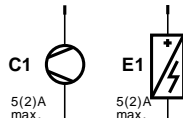

7. Mechanical design

7.1 General

The thermostats consist of 2 parts:

- Front panel with electronics, operating elements and built-in room temperature sensor.
- Mounting base with power electronics.

The rear of the mounting base carries the screw terminals.
Slide the front panel in the mounting base and snap on.

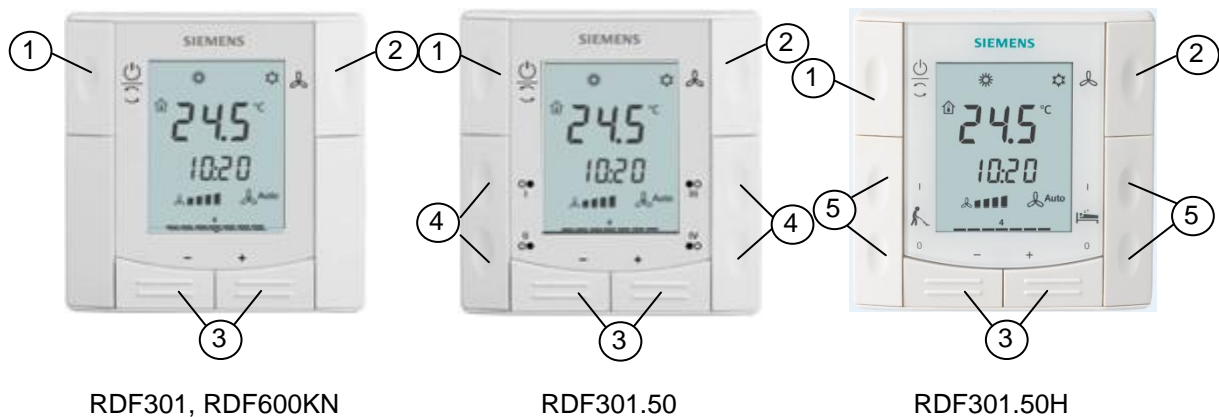

- RDF301, RDF600KN
- RDF301.50
- RDF301.50H
- 1 Operating mode selector
 - 2 Button for fan operation
 - 3 Buttons to adjust setpoints and control parameters
 - RDF301.50 4 Four buttons to control KNX actuators via KNX S-Mode (functions: switching, dimming, blind control, 8-bit scene)
 - RDF301.50H 5 Four dedicated buttons for hotel functions (Make Up Room, Do Not Disturb) via KNX S-Mode (functions: switching)

For operation, refer to section 4.3.

7.2 Dimensions

Dimensions in mm

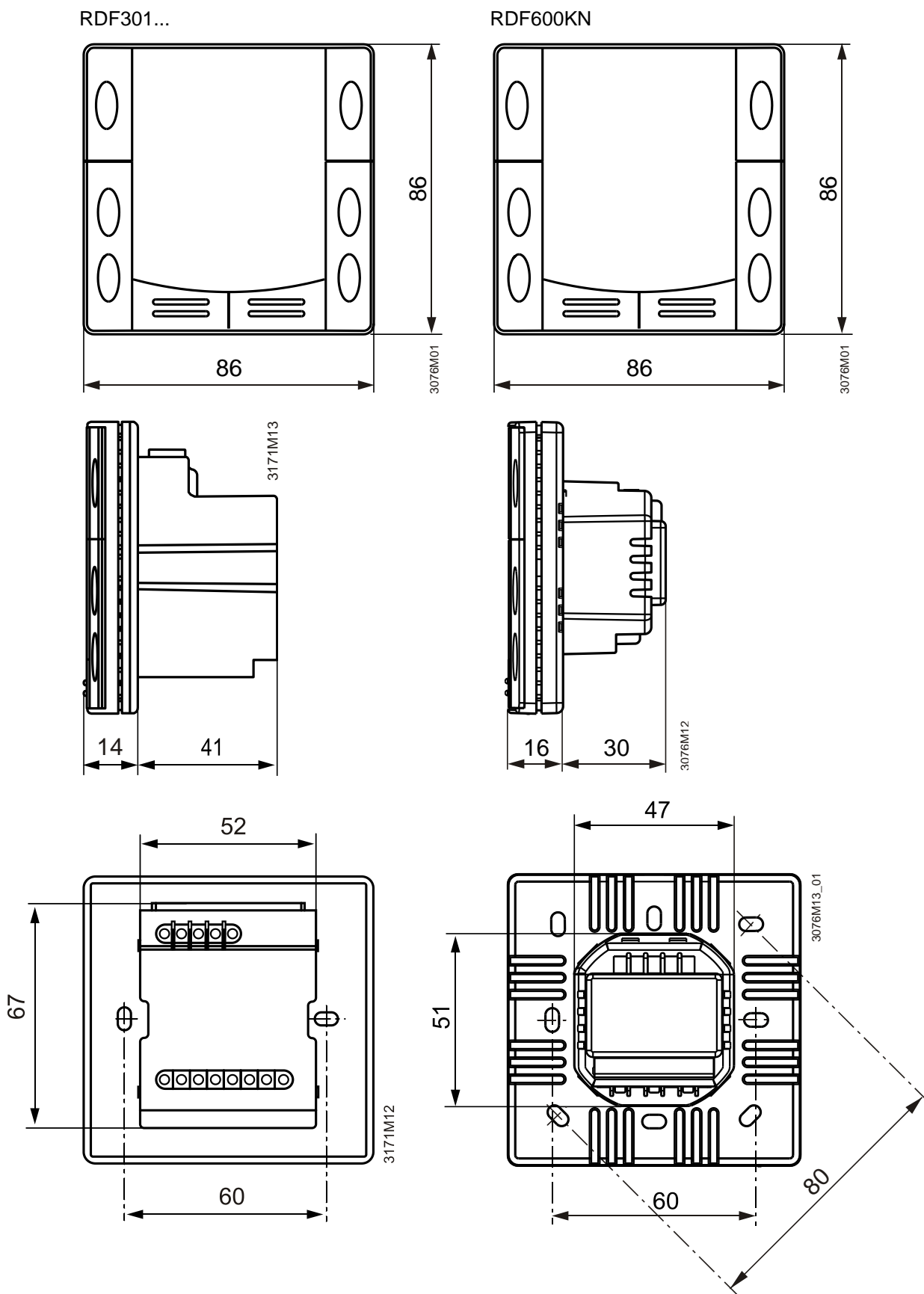

8. Technical data

 Power supply

Rated voltage	AC 230 V
Overvoltage category	III
Frequency	50/60 Hz
Power consumption	
RDF301...	Max. 4 VA / 3.0 W
RDF600KN	Max. 3.5 VA / 1.2 W

 Caution

No internal fuse!
External preliminary protection with max C 10A circuit breaker is required in all cases.

Outputs

Fan control Q1, Q2, Q3-N	AC 230 V
Rating Min, Max resistive (inductive)	Min. 5 mA, Max. 5(2) A

 Note!

Fans must NOT be connected in parallel!

Connect one fan directly, for additional fans, one relay for each speed.

Control output Y11-N / Y21-N (NO)	AC 230 V
Rating Min, Max resistive (inductive)	Min. 5 mA, Max. 5(2) A

Max. total load current through terminal "L" (Qx+Yxx)	Max. 7A
--	---------

 Caution

No internal fuse
External preliminary protection with max. C 10 A circuit breaker in the supply line required under all circumstances





Inputs

Multifunctional input X1-M/X2-M	
Temperature sensor input	
Type	QAH11.1 (NTC)
Temperature range	0...49 °C
Cable length	Max. 80 m
Digital input	
Operating action	Selectable (NO/NC)
Contact sensing	SELV DC 0...5 V/
Parallel connection of several thermostats for one switch	max. 5 mA
Insulation against mains voltage (SELV)	Max. 20 thermostats per switch
	4 kV, reinforced insulation
Function of inputs:	Selectable
External temperature sensor, heating / cooling	X1: P38
changeover sensor, operating mode switchover	X2: P40
contact, dew point monitor contact, enable electric heater contact, fault contact, monitoring input	

KNX bus

Interface type	KNX, TP1-64 (electrically isolated)
Bus current	RDF301... 20 mA
	RDF600KN 5 mA

Bus topology: See KNX Manual (see section 1.2 "Reference documents")

Operational data	Switching differential (adjustable)		
	Heating mode	(P30)	2 K (0.5...6 K)
	Cooling mode	(P31)	1 K (0.5...6 K)
	Setpoint setting and range		
	 Comfort	(P08)	21°C (5...40 °C)
	 Economy	(P11-P12)	15°C/30 °C (OFF, 5...40 °C)
	 Protection	(P65-P66)	8°C/OFF (OFF, 5...40 °C)
	Multifunctional input X1/X2		
	Input X1 default value	(P38)	3 (operating mode switchover)
	Input X2 default value	(P40)	1 (external temperature sensor)
	Built-in room temperature sensor		
	Measuring range		0...49 °C
	Accuracy at 25 °C		< ± 0.5 K
	Temperature calibration range		± 3.0 K
	Settings and display resolution		
Setpoints		0.5 °C	
Current temperature value displayed		0.5 °C	
Environmental conditions	Operation		
	Climatic conditions		IEC 60721-3-3
	Temperature		Class 3K5
	Humidity		0...50 °C
	Transport		<95% r.h.
	Transport		
	Climatic conditions		IEC 60721-3-2
	Temperature		Class 2K3
	Humidity		-25...60 °C
	Mechanical conditions		<95% r.h.
	Storage		
	Climatic conditions		IEC 60721-3-1
Temperature		Class 1K3	
Humidity		-25...60 °C	
Standards and directives	EU Conformity (CE)		
		RDF301...	CE1T3171xx ^{*)}
		RDF600KN	CE1T3171xx_1 ^{*)}
	Electronic control type		2.B (micro-disconnection on operation)
	 RCM Mark conformity (Emission)	RDF301...	CE1T3171en_C1 ^{*)}
		RDF600KN	CE1T3076en_C1 ^{*)}
	Safety class		II as per EN60730
	Pollution class		Normal
	Degree of protection of housing		IP30 as per EN60529
	Environmental Compatibility	The product environmental declaration CE1E3076_3en ^{*)} (for RDF600KN) contains data on environmentally compatible product design and assessments (RoHS compliance, materials composition, packaging, environmental benefit, disposal).	
General	Connection terminals		
			Solid wires or prepared stranded wires
			1 x 0.4...1.5 mm ²
	Minimal wiring cross section on L, N, Q1, Q2, Q3, Y11, Y21		min 1.5 mm ²
	Housing front color		RAL 9003 white
Weight without / with packaging	RDF301...	0.240 kg / 0.320 kg	
	RDF600KN	0.150 kg / 0.220 kg	

^{*)} The documents can be downloaded from <http://siemens.com/bt/download>.

Index

1	
1-speed fan	49
3	
3-position control signal	46
3-speed fan	49
A	
Applications overview	28
Auto Timer mode	17
Automatic heating / cooling changeover.....	32, 35
Automatic heating / cooling changeover via bus ..	32
B	
Basic application	42
Button lock	34
C	
Celsius	14
Changeover switch	32
Chilled / heated ceiling applications	42
Clean fan filter reminder	50
Compressor applications	30, 31, 43
Control outputs configuration.....	47
Control outputs overview	46
Control parameters	67
Control sequences	35
Cooling demand.....	58
Cooling sequence	35
D	
Dew point monitoring	34, 51
Diagnostic	67
Disposal	77
E	
Effect of Protection via time schedule.....	17
Electric heater	39
Enable / disable electric heater.....	39, 52
Expert level parameters.....	67
Extension of Comfort mode	20
External / return air temperature.....	51
External / return air temperature sensor.....	32
F	
Fahrenheit.....	14
Fan in Auto Timer mode.....	50
Fan in dead zone	69
Fan kick function.....	49
Fan minimum on-time	49
Fan operation as per heating / cooling mode, or disabled.....	49
Fan operation in dead zone.....	49
Fan overrun	50
Fan start	50
Fan start delay.....	50
Fault.....	52
Fault on KNX	59
Fault, handling.....	53
Floor cooling	33
Floor heating.....	33
Floor temperature limitation function	33
H	
Heating / cooling changeover.....	32, 51
Heating and cooling sequence	35
Heating demand	58
Heating sequence.....	35
I	
Integral action time	14
K	
KNX addressing.....	75
M	
Main and secondary	41
Manual heating / cooling changeover	32
Minimum output.....	33
Moisture	33
Mounting and installation.....	73
Multifunctional inputs.....	51
O	
ON/OFF control signal.....	46
Operating mode	
Priority intervention	16
Operating mode button.....	17
Operating mode switchover.....	51
Outside temperature.....	14
P	
Parameter setting	67
Power failure.....	53
Precomfort	17
Presence detector	15
Proportional band	14
Protection mode / Standby	15
Purge function	33
PWM.....	46

R			
Radiator applications	42	Standby / Protection mode	15
Reload factory settings	67	Switching differential	14
Remote heating / cooling changeover	32	Switching groups	60
Reset parameters	67	Synchronization	46
S		T	
Sensor input.....	51	Temperature out of range	53
Setpoint Comfort mode.....	44	Temporary setpoint.....	25
Setpoint Economy mode	44	Test.....	67
Setpoint limitation	25	Time of day.....	14
Setpoint priority	28	Time schedule change mode	17
Setpoint Protection mode	44	W	
Setpoints and sequences	44	Window state	15, 16, 51

