

**de** Montageanleitung  
**en** Mounting instructions  
**fr** Instructions de montage  
**sv** Monteringsinstruktion  
**nl** Montage-aanwijzing  
**it** Istruzioni di montaggio  
**fi** Asennusohje  
**es** Instrucciones de montaje  
**da** Monteringsvejledning

**Linearantrieb**  
**Linear-type actuator**  
**Servo-moteur à action linéaire**  
**Spjällställdon med linjär rörelse**  
**Luchtklepservomotor voor lineare aandrijving**  
**Servocomando lineare**  
**Työntölikkeinen ilmapeltien toimimoottori**  
**Actuador de acción lineal**  
**Motor for lineær bevægelse**

## GEB...2

### A

**Lieferumfang**  
**Delivrables**  
**Contenu**

**Leverans**  
**Leveringsomvang**  
**Contenuto**

**Toimituslaajuus**  
**Contenido**  
**Leverancens omfang**

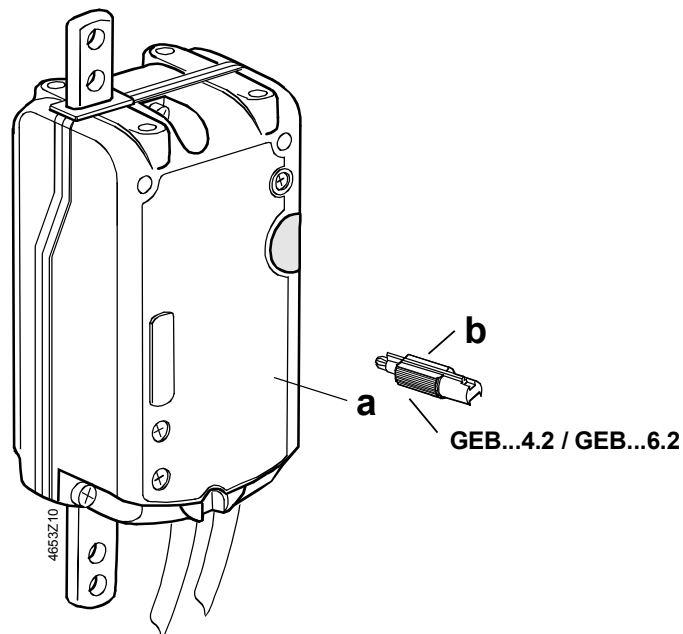

### B

**Hinweise / Warnungen**  
**Notes / Warnings**  
**Indications / Mise en garde**

**Hänvisningar / Varningar**  
**Aanwijzingen / Waarschuwingen**  
**Messa in servizio / Indicazioni**

**Huomauksia / Varoituksia**  
**Indicaciones / Consejos**  
**Bemærkninger / Advarsler**

**IP40**  
 In all positions

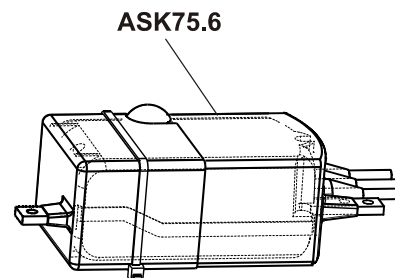
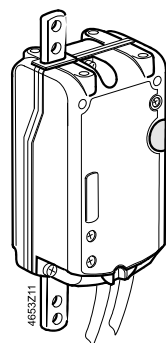
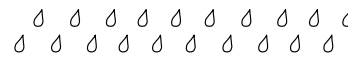

**de**

**Diese Anleitung ist beim Antrieb oder in der Anlagendokumentation aufzubewahren!**

 Dieses Symbol weist auf Gefahren und Massnahmen zum Schutz von Personen und Sachen hin:

- Antriebe für AC 230 V dürfen nur durch autorisiertes Personal angeschlossen werden.
- Zulässige Spannungen an den Hilfsschaltern: Siehe Tabelle unter "Geräteschaltpläne".
- Die Anschlusskabel des Antriebs dürfen nicht im Wasser liegen.

 Gerät der Schutzklasse II (Schutzisolierung)

 Gerät der Schutzklasse III (Schutzisolierung)

 **Achtung!** Der Stellantrieb darf nicht geöffnet werden

#### Verdrahtung und Inbetriebnahme

Siehe in den anlagenspezifischen Unterlagen und in der Basisdokumentation "Technische Grundlagen" CM2Z4653 zum Antrieb.

**sv**

**Denna instruktion skall förvaras tillsammans med ställdonet eller anläggningsdokumentationen!**

 Denna symbol gäller riskfaktorer samt åtgärder för att undvika person- och materialskador.

- Ställdon med AC 230 V får anslutas endast av behörig personal.
- Tillåten spänning för hjälpkontakter, se tabellen i avsnitt kopplingscheman.
- Ställdonets anslutningskabel får inte ligga i vatten.

 Apparat i isolerklasse II (skyddsisolering)

 Apparat i isolerklasse III (skyddsisolering)

 **OBS!** Ställdonet får inte öppnas.

#### Elektrisk inkoppling och igångkörning

Se anläggningspecifika underlag och grundläggande beskrivning "Handbok CM2Z4653" för ställdonet.

**fi**

**Tätä ohjetta tulee säilyttää toimimootorin läheisyydessä tai yhdessä laitosdokumenttien kanssa!**

 Tämä symboli viittaa vaaraan ja toimenpiteisiin, joita tarvitaan henkilö- ja aineellisten vahinkojen välttämiseksi:

- Ainoastaan valtuutetut ammattihenkilöt saavat liittää 230 VAC:n toimimootoreita.
- Sallitut jännitteet apukytkimissä: katso "Kytentäkaaviot"-kappaleessa oleva taulukko.
- Toimimootorin liitäntäkaapelit eivät saa kastua tai muuten altistua vedelle.

 Suojausluokan II laite (suoraerotus)

 Suojausluokan III laite (suojerotus)

 **Huomio!** Toimimootoria ei saa avata.

#### Johdotus ja käyttöönotto

Katso laitoskohtaiset dokumentit ja toimimootorin tekninen käsikirja CM2Z4653.

**en**

**Store these instructions together with the actuator or with the plant documentation!**

 This symbol denotes dangers and measures to avoid personal injury and property damage:

- Only authorized personnel may connect actuators for AC 230 V.
- Refer to the table in "Diagrams" for the voltages permissible at the auxiliary switches.
- Do not expose the actuator's connecting cables to water or lay the cables in water.

 Device of protection class II (protective insulation)

 Device of protection class III (protective insulation)

 **Warning!** Do not open the actuator.

#### Wiring and commissioning

Refer to the actuator's commissioning instructions and document "Technical basics" CM2Z4653.

**nl**

**Deze handleiding moet bij de servomotor, of met de documentatie van de installatie worden bewaard!**

 Dit symbool wijst op gevaar en maatregelen ter bescherming van personen en materiaal:

- AC 230 V aandrijvingen mogen alleen door bevoegd personeel worden aangesloten.
- Voor toelaatbare spanningen aan hulpschakelaars: Zie tabel onder "Aansluitschema's"
- De aansluitkabel van de aandrijving mag niet in het water liggen.

 Apparaat van beschermingsklasse II (beschermings isolatie)

 Apparaat van beschermingsklasse III (beschermings isolatie)

 **Opgelet!** De servomotor mag niet worden geopend.

#### Bekabeling en inbedrijfstelling

Raadpleeg de installatie-documentatie en de basisdocumentatie "technische grondslagen" CM2Z4653 van de servomotor.

**es**

**Conserve estas instrucciones con el actuador o con la documentación de la instalación!**

 Este símbolo denota peligro y medidas para evitar daños personales y de la propiedad:

- Sólo el personal autorizado puede conectar los actuadores a 230 V CA.
- Consultar la tabla de "Conexión eléctrico" para saber la tensión permitida en los contactos auxiliares
- No exponer los cables de conexión del actuador al agua ni dejarlos en contacto con ésta.

 Equipo con tipo de protección II (aislamiento protegido)

 Equipo con tipo de protección III (aislamiento protegido)

 **Atención!** el actuador no debe ser abierto.

#### Cableado y puesta en marcha

Ver la documentación técnica "Technical basics" CM2Z4653 del actuador.

**fr**

**Cette instruction est à conserver avec le servo-moteur ou avec la documentation de l'installation!**

 Ce symbole signale un danger pour les personnes et les biens et les mesures y-afférentes :

- Le branchement des servomoteurs 230 V~ ne doit être effectué que par un personnel qualifié.
- Tensions admissibles sur les contacts auxiliaires : cf. "Schémas de raccordement"
- Les câbles de raccordement du servomoteur ne doivent pas être en contact avec l'eau.

 Classe d'isolation II (isolation de protection)

 Classe d'isolation III (isolation de protection)

 **Attention!** Le servo-moteur ne doit pas être ouvert.

#### Câblage et mise en service

se référer à la documentation de l'installation et au manuel technique CM2Z4653 du servomoteur.

**it**

**Queste istruzioni devono essere conservate con la documentazione dell'impianto!**

 Questo simbolo indica – pericolo – il personale deve fare attenzione per evitare ferite o danni.

- I collegamenti a 230 V CA . devono sempre essere eseguiti da personale autorizzati.
- Fare riferimento alle " tabelle tecniche" per la tensione ammessa per i contatti ausiliari.
- Non esporre all'acqua il cavo ed i collegamenti elettrici.

 Apparecchi di protezione classe II (protezione isolamento)

 Apparecchio di protezione classe III (protezione isolamento)

 **Attenzione!** Il servocomando non deve essere aperto.

#### Collegamenti e messa in servizio

Consultare la documentazione per l'installazione e il foglio tecnico (CM2Z4653) del servocomando.

**da**

**Opbevar denne vejledning sammen med motoren eller med anlægssdokumentationen!**

 Dette symbol gør opmærksom på farer og forholdsregler til beskyttelse af personer og genstande:

- Motorer til AC 230 V må kun tilsluttes af autoriserede personer.
- Tilladte spændinger til hjælpekontakter: Se skema under "Apparatdiagrammer"
- Motorens tilslutningskabler må ikke ligge i vand.

 Apparat i isoleringsklasse II (beskyttelsesisolering)

 Apparat i isoleringsklasse III (beskyttelsesisolering)

 **OBS!** Motoren må ikke åbnes.

#### Eltilslutning og idriftsættelse

Se den anlægsspecifikke dokumentation samt basisdokumentationen "Tekniske principper" CM2Z4653 for motoren.



**Adapter-Montage**  
**Adapter mounting**  
**Montage de l'adaptateur**

**Montering av adapter**  
**Apadper-montage**  
**Montaggio dell'adattatore**

**Sovittimen asennus**  
**Montaje del adaptador**  
**Montering af adapter**

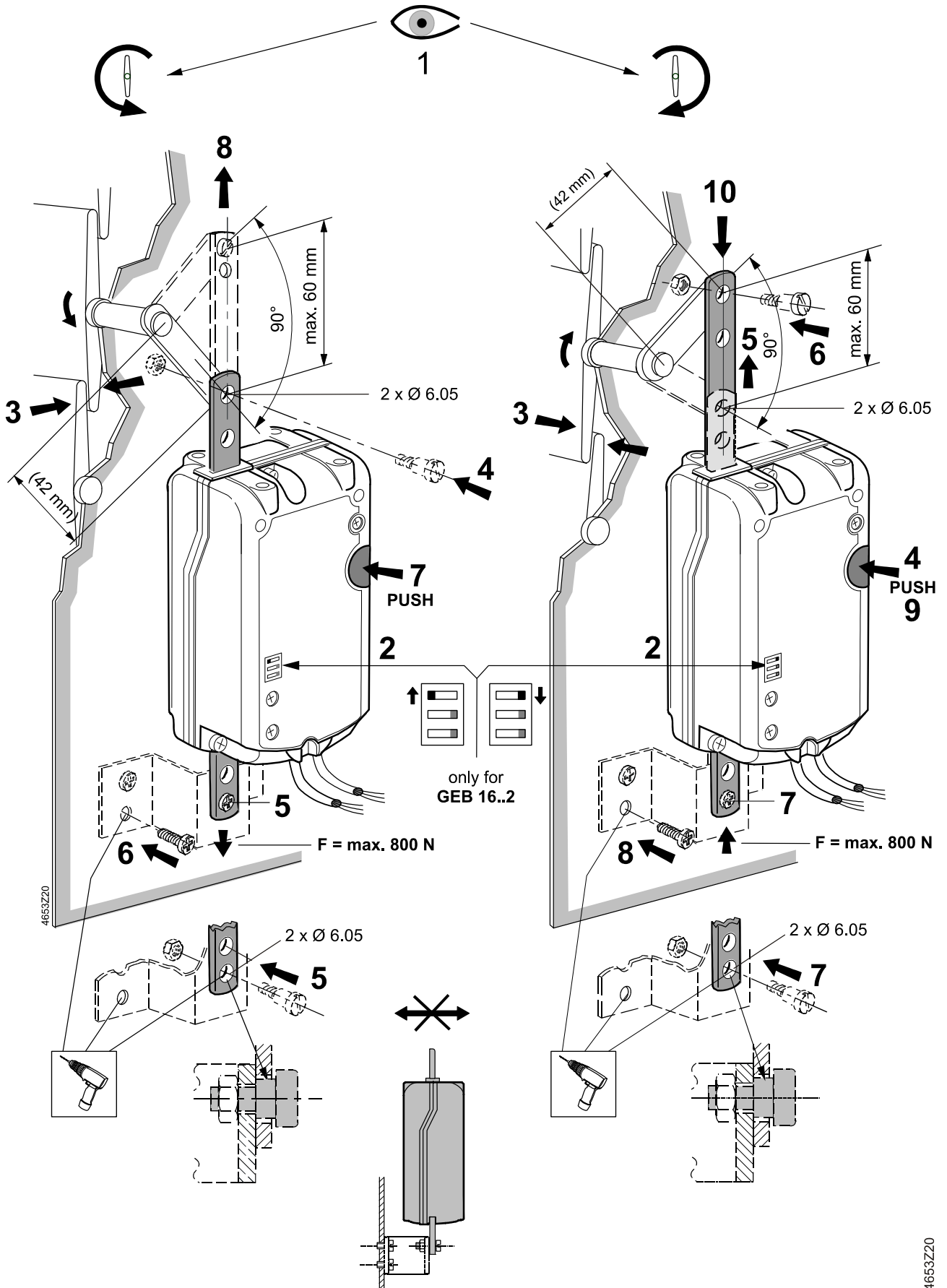

# D

## Anwendung Application Application

- für Drehklappen
- for rotary damper
- pour volets à commande par rotation
- för spjäll med vridande rörelse
- Voor roterende kleppen
- per serrande a comando rotativo
- kiertoliikepeltien kanssa
- Para compuertas rotativas
- for drejespjæld

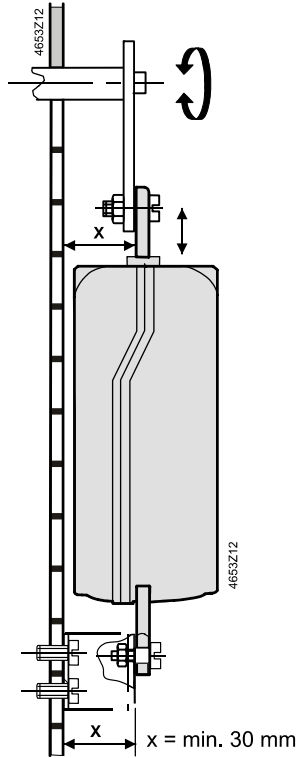

## Användning Toepassing Applicazioni

- für Hubklappen
- for linear damper
- pour volets à commande lineaire
- för spjäll med linjär rörelse
- Voor roterende kleppen
- per serrande a comando lineare
- työntöliikepeltien kanssa
- Para compuertas lineales
- for spjæld for lineær bevægelse

## Käyttö Aplicación Anvendelse

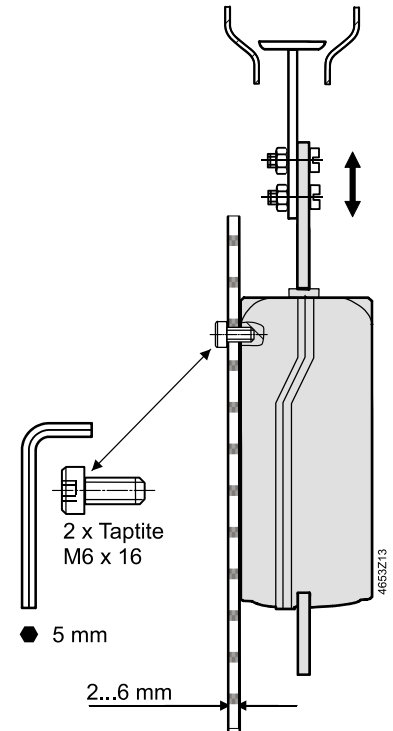

# E

**Einstellung: Hilfsschalter A, B**  
**Setting: Auxiliary switches A, B**  
**Réglage: Contact auxiliaire A, B**

**Inställning: Hjälpkontakt A, B**  
**Instelling: Hulpshakelaar A, B**  
**Taratura: Contatto ausiliario A, B**

**Asettelu: Apukytkin A, B**  
**Ajuste: Contacto auxiliar A, B**  
**Indstilling: Hjælpekontakt A, B**

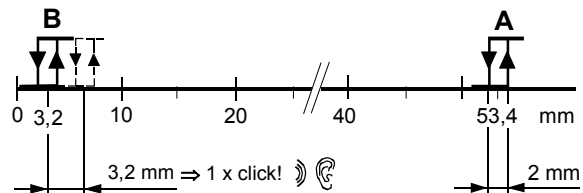
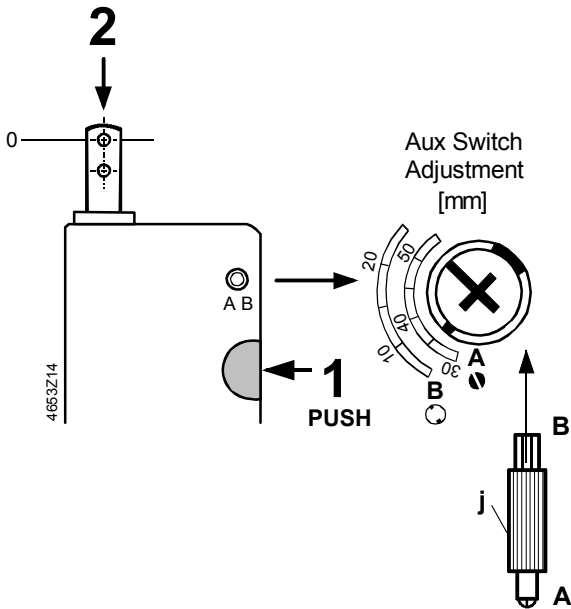

Werkeinstellung  
Factory setting  
Préreglé à l'usine  
Fabriksinställning  
Fabriksmatig ingestelde

Alla consegna  
Tehdasasetus  
Ajuste de fábrica  
Fabriksindstillet

**A = 53.4**  
**B = 3.2**

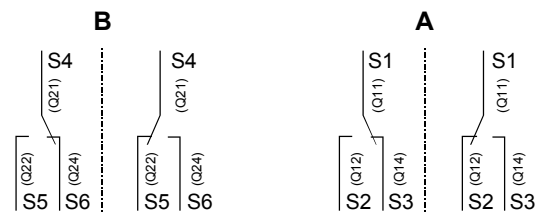

**F**

**Massbild**  
**Dimensions**  
**Encombremnt**

**Måttuppgift**  
**Maatschets**  
**Ingombri**

**Mittapiirros**  
**Dimensiones**  
**Målskitse**

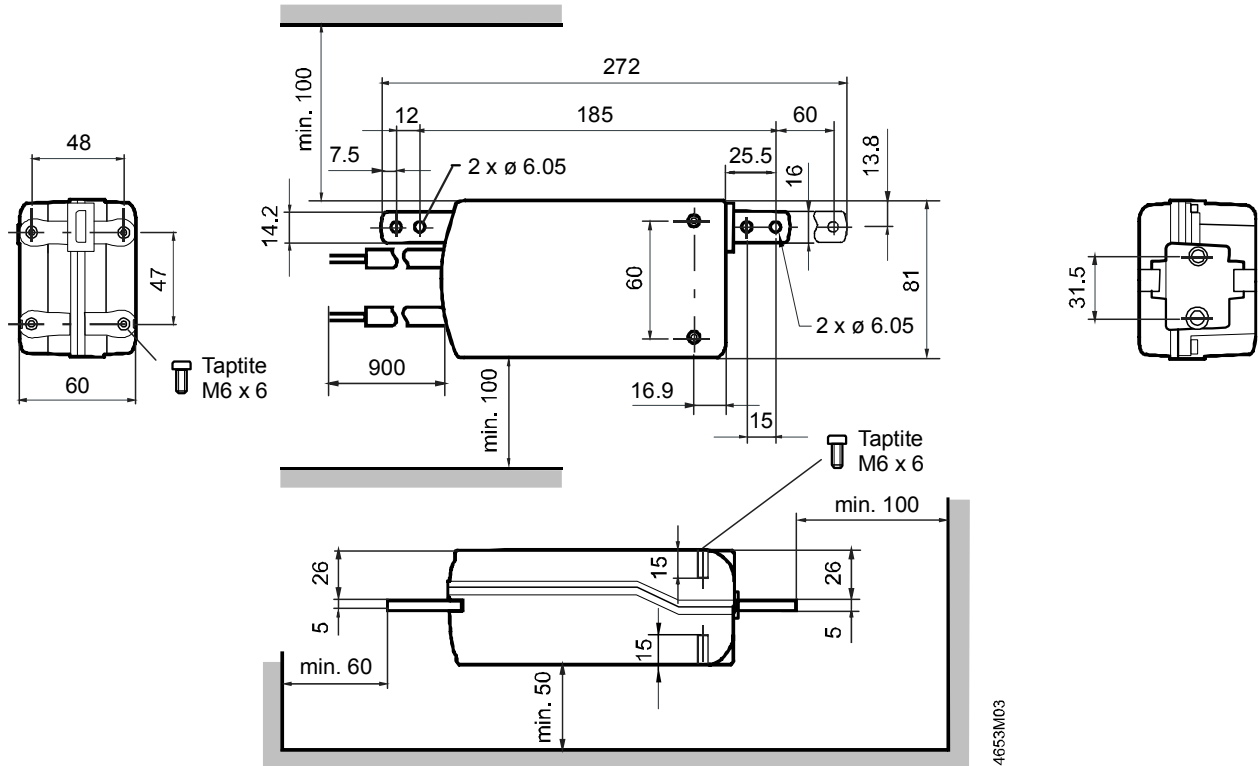

Masse in mm  
 Dimensions in mm  
 Dimensions en mm

Mått i mm  
 Afmetingen in mm  
 Dimensioni in mm

Mitat mm  
 Dimensiones en mm  
 Mål i mm



GEB131.2E  
GEB136.2E

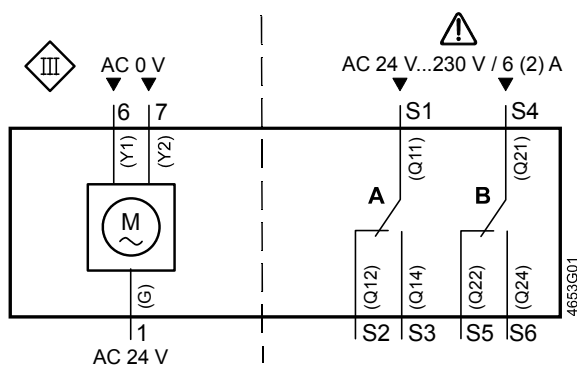

**AC 24 V**

Dreipunkt-Steuerung  
Three-position control  
Commande 3 points  
Treläges styrning  
Driepuntsbesturing  
Comando a 3 punti  
Kolmipisteohjaus  
Control a 3 puntos  
Trepunksstyrning

GEB331.2E  
GEB336.2E

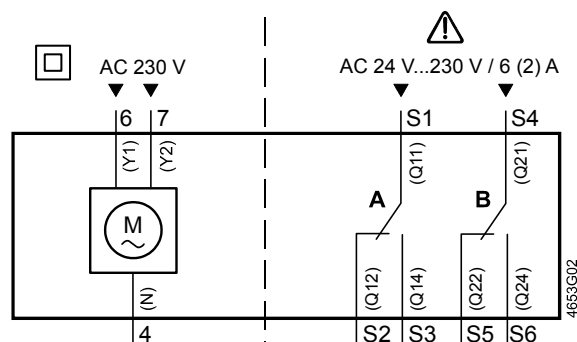

**AC 230 V**

Dreipunkt-Steuerung  
Three-position control  
Commande 3 points  
Treläges styrning  
Driepuntsbesturing  
Comando a 3 punti  
Kolmipisteohjaus  
Control a 3 puntos  
Trepunksstyrning

GEB161.2E  
GEB163.2E

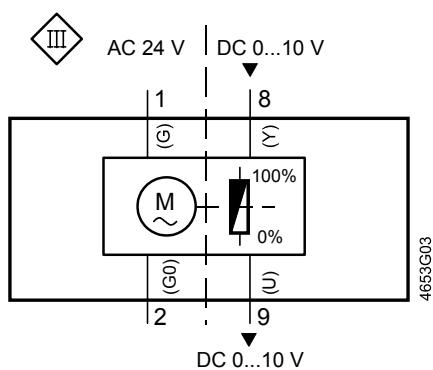

**AC 24 V**

Stetigsteuerung DC 0...10 V  
Continuous control DC 0...10 V  
Commande progressif DC 0...10 V  
Kontinuerlig styrsignal 0...10 V DC  
Modulerende besturing 0...10 VDC  
Comando analogico 0...10V c.c.  
Moduloiva ohjaus 0...10 V DC  
Control continuo 0...10 V CC  
Kontinuerlig styrning DC 0...10 V

Voltage	Switch A (S1)	Switch B (S4)	ok / no!
AC 24 V	AC 24 V	AC 24 V	ok
AC 230 V	L1 (phase) L2 L3 L <sub>x</sub> (phase)	L1 (phase) L2 L3 ≠ L <sub>x</sub> (phase)	ok ok ok no!
mixed	AC 24 V AC 230 V	AC 230 V AC 24 V	no! no!

de

## Kabelbezeichnungen

Anschluss	Kabel				Bedeutung
	Code	Nr.	Farbe	Akürzung	
Antriebe AC 24 V	G	1	rot	RD	System Potential AC 24 V
	G0	2	schwarz	BK	Systemnull
	Y1	6	violett	VT	Stellsignal AC 0 V, "Einfahren"
	Y2	7	orange	OG	Stellsignal AC 0 V, "Ausfahren"
	Y	8	grau	GY	Stellsignal DC 0...10 V, 2...10 V, 0...35 V
	U	9	rosa	PK	Stellungsanzeige DC 0...10 V
Antriebe AC 230 V	N	4	blau	BU	Nullleiter
	Y1	6	schwarz	BK	Stellsignal AC 230 V, "Einfahren"
	Y2	7	weiss	WH	Stellsignal AC 230 V, "Ausfahren"
Hilfsschalter	Q11	S1	grau/rot	GYRD	Schalter A Eingang
	Q12	S2	grau/blau	GYBU	Schalter A Ruhekontakt
	Q14	S3	grau/rosa	GYPK	Schalter A Schliesskontakt
	Q21	S4	schwarz/rot	BKRD	Schalter B Eingang
	Q22	S5	schwarz/blau	BKBU	Schalter B Ruhekontakt
	Q24	S6	schwarz/rosa	BKPK	Schalter B Schliesskontakt

en

## Wire designations

Connecting	Cable				Meaning
	Code	No.	Color	Abbreviation	
AC 24 V Actuators	G	1	red	RD	System potential AC 24 V
	G0	2	black	BK	System neutral
	Y1	6	purple	VT	Actuating signal AC 0 V, "retract"
	Y2	7	orange	OG	Actuating signal AC 0 V, "drawout"
	Y	8	gray	GY	Actuating signal DC 0...10 V, 2...10 V, 0...35 V
	U	9	pink	PK	Position indication DC 0...10 V
AC 230 V Actuators	N	4	blue	BU	Neutral
	Y1	6	black	BK	Actuating signal AC 230 V, "retract"
	Y2	7	white	WH	Actuating signal AC 230 V, "drawout"
Auxiliary switch	Q11	S1	gray/red	GYRD	Switch A input
	Q12	S2	gray/blue	GYBU	Switch A normally closed contact
	Q14	S3	gray/pink	GYPK	Switch A normally open contact
	Q21	S4	black/red	BKRD	Switch B input
	Q22	S5	black/blue	BKBU	Switch B normally closed contact
	Q24	S6	black/pink	BKPK	Switch B normally open contact

fr

## Désignation des câbles

Câbles de raccordement	Câble				Signification
	Code	No.	Couleurs	Abbreviation	
servo-moteurs AC 24 V	G	1	rouge	RD	potentiel du système AC 24 V
	G0	2	noir	BK	zéro du système
	Y1	6	violet	VT	signal de comm. AC 0 V, "rentrée de l'axe"
	Y2	7	orange	OG	signal de comm. AC 0 V, "sortie de l'axe"
	Y	8	gris	GY	signal de commande DC 0...10 V, 2...10 V, 0...35 V
	U	9	rose	PK	signal de position DC 0...10 V
servo-moteurs AC 230 V	N	4	bleu	BU	neutre
	Y1	6	noir	BK	Signal de commande AC 230 V "rentrée de l'axe"
	Y2	7	blanc	WH	Signal de commande AC 230 V "sortie de l'axe"
commutateurs auxiliaires	Q11	S1	gris/rouge	GYRD	commutateur A entrée
	Q12	S2	gris/bleu	GYBU	commutateur A contact de repos
	Q14	S3	gris/rose	GYPK	commutateur A contact de travail
	Q21	S4	noir/rouge	BKRD	commutateur B entrée
	Q22	S5	noir/bleu	BKBU	commutateur B contact de repos
	Q24	S6	noir/rose	BKPK	commutateur B contact de travail

